



LB-460-NF Broadband Horn Antenna 0.4-6.0 GHz 10dB Gain N Type Female

Broadband Horn Antenna Operating From 0.4GHz to 6.0GHz With a Nominal 10 dB Gain With N Type Female Connector

Product Information

SKU	LB-460-NF	Patents	ZL201630454765.2 (China)
-----	-----------	---------	--------------------------

Description

Broadband horn antenna LB-460-NF, operating from 0.4 to 6GHz with a nominal 10dB gain and low VSWR 1.5:1 with N Type Female output connector. The model LB-460-NF has uniform gain through its frequency span, providing efficient performance characteristics and directionality. It can handle 500W continuously and 800W peak power. Constructed of lightweight corrosion-resistant aluminum, the antenna will provide years of trouble-free indoor and outdoor service. This broadband horn antenna is linearly polarized and ideally suited for EMI testing, direction finding, surveillance, antenna gain and pattern measurements and other applications.

Technical Specification

Electrical Specification		Interface	
Frequency, Min (GHz)	0.4	Output Type	Coaxial
Frequency, Max (GHz)	6	Connector	N Type
Gain, Typ (dBi)	10	Connector Gender	Female
Polarization	Linear	Mechanical Specification	
3dB Beamwidth, E-Plane, Min (Deg.)	31	Body Material	Al
3dB Beamwidth, E-Plane, Max (Deg.)	104	Finish	Chemical Conversion Coating
3dB Beamwidth, H-Plane, Min (Deg.)	35	Size, W (mm)	492
3dB Beamwidth, H-Plane, Max (Deg.)	94	Size, H (mm)	320
Cross Pol. Isolation, Typ (dB)	25	Size, L (mm)	436
VSWR, Typ	1.5:1	Weight, (kg)	7.4
Impedance, (Ohm)	50		
Power Handling, CW, (W)	500		
Power Handling, Peak, (W)	800		

Additional Information

Application	General Purpose Indoor & Outdoor, Fixed	Solution for	Gain Reference Antenna Measurement Reflector Feed Far-field Measurement System Intergration
-------------	---	--------------	---

Outline Drawing

N-Female Output (P/N: LB-460-NF)

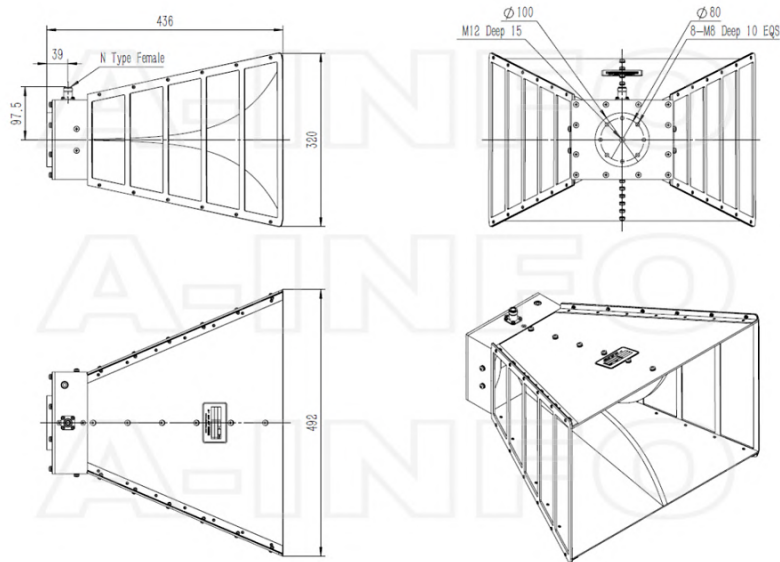

N-Female Output with L Type Mounting Bracket (Option, P/N: LB-460-L)

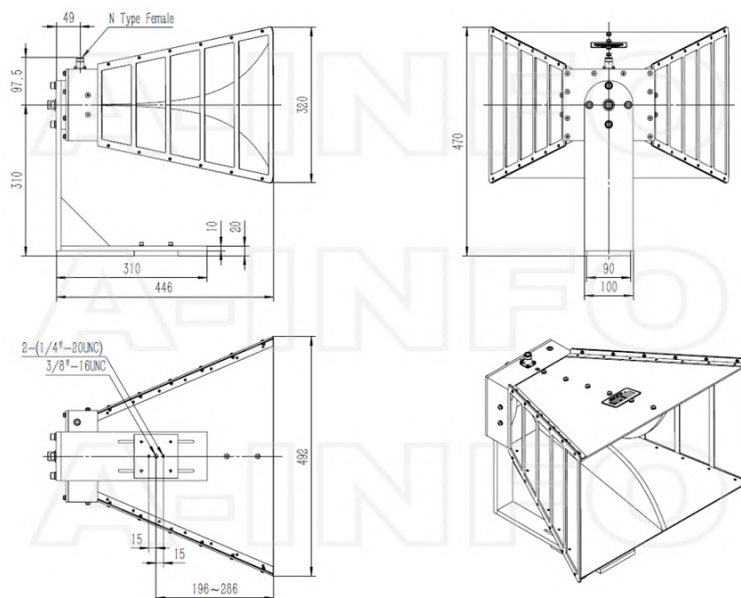

Typical Test Results

Gain

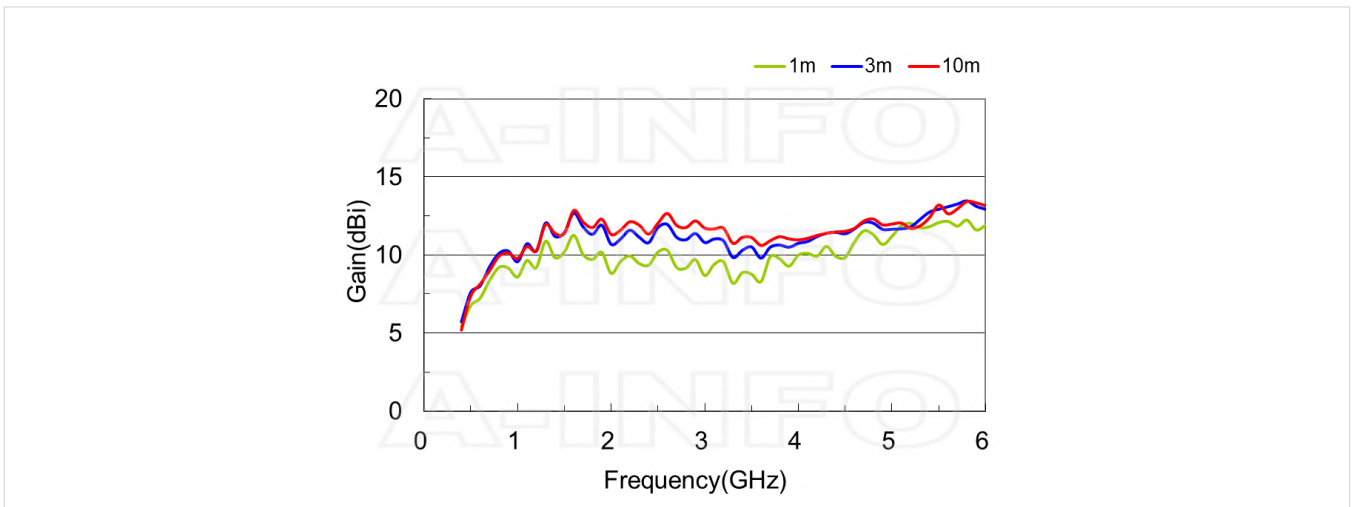

Antenna Factor

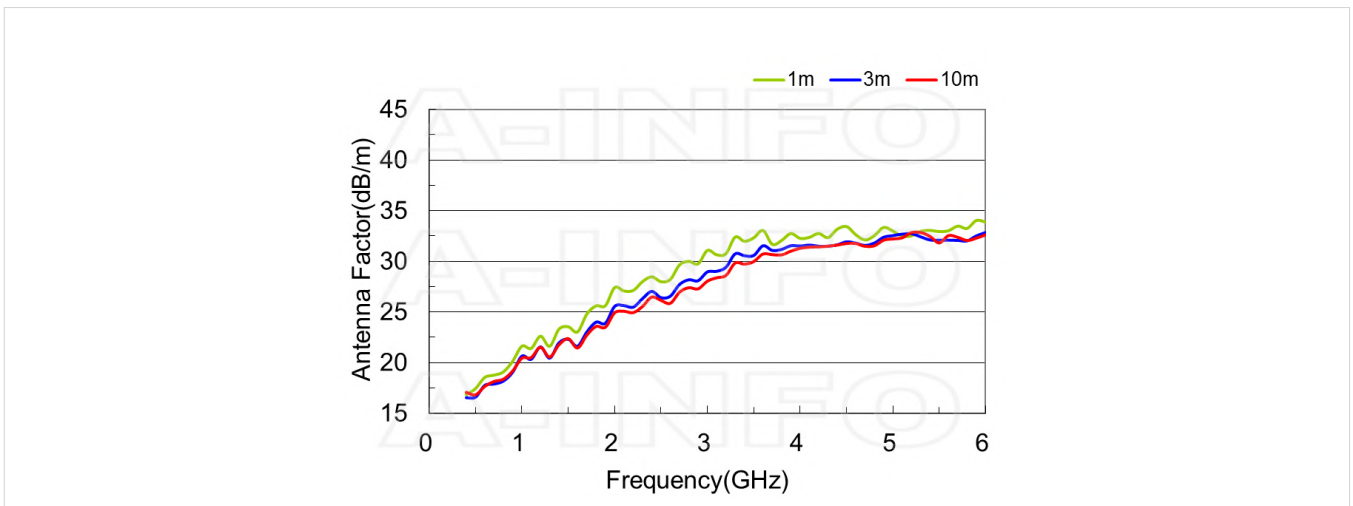

Antenna Factor (Table)

Frequency(GHz)	1m		3m		10m	
	Gain(dBi)	AF(dB/m)	Gain(dBi)	AF(dB/m)	Gain(dBi)	AF(dB/m)
0.40	5.42	16.83	5.72	16.53	5.19	17.06
0.50	6.76	17.43	7.61	16.58	7.38	16.81
0.60	7.24	18.54	8.02	17.75	8.13	17.65
0.70	8.35	18.76	9.23	17.88	8.98	18.13
0.80	9.20	19.08	10.09	18.18	9.91	18.36
0.90	9.17	20.13	10.26	19.04	10.13	19.16
1.00	8.59	21.62	9.57	20.64	9.78	20.43
2.00	8.83	27.40	10.69	25.55	11.32	24.91
3.00	8.68	31.07	10.80	28.95	11.71	28.04
4.00	9.99	32.26	10.75	31.50	10.97	31.28
5.00	11.20	32.99	11.65	32.54	11.99	32.20
6.00	11.91	33.87	12.93	32.84	13.16	32.62

Field Strength

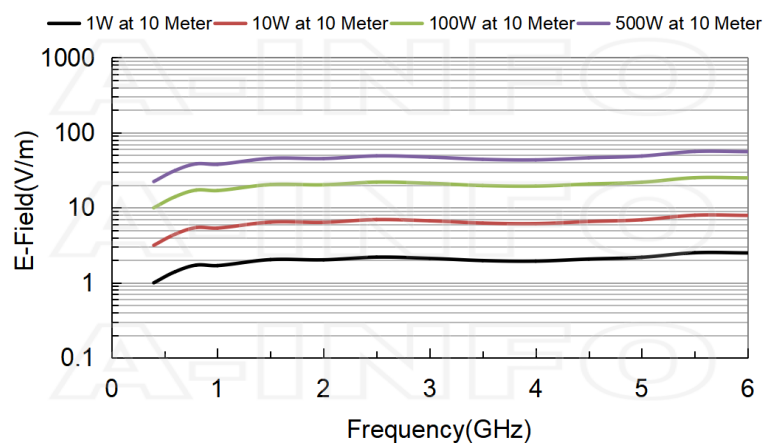
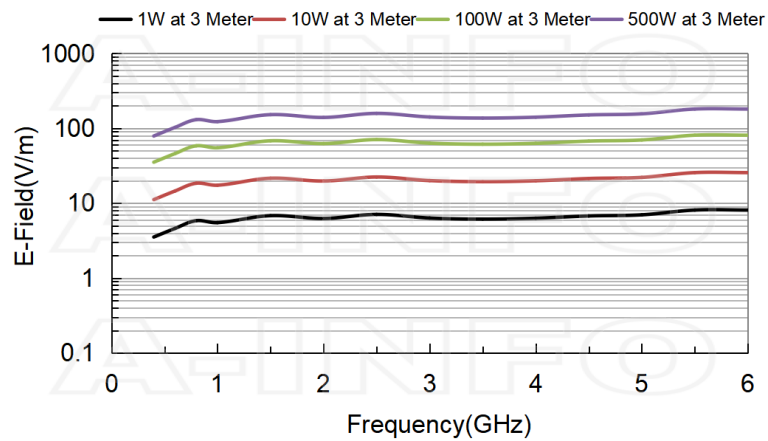
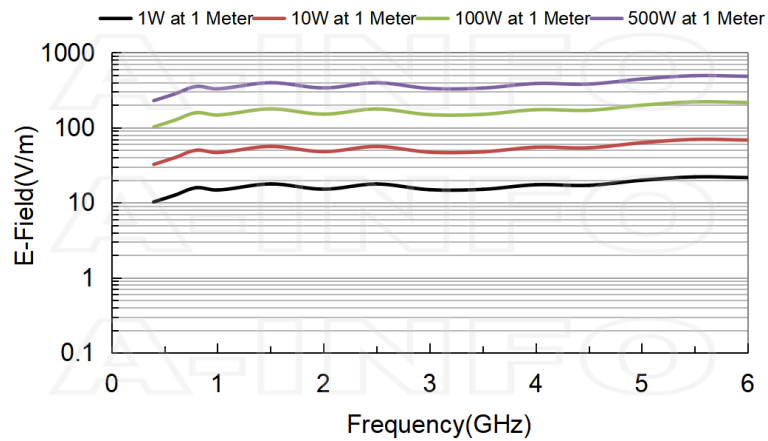

Cross Polarization Isolation

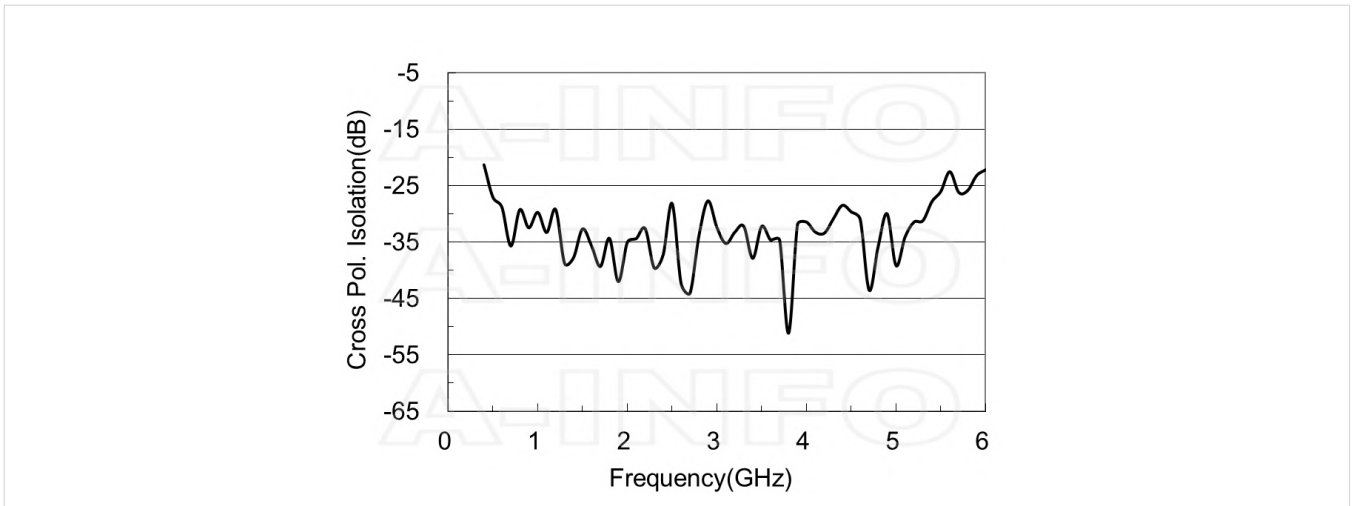

VSWR

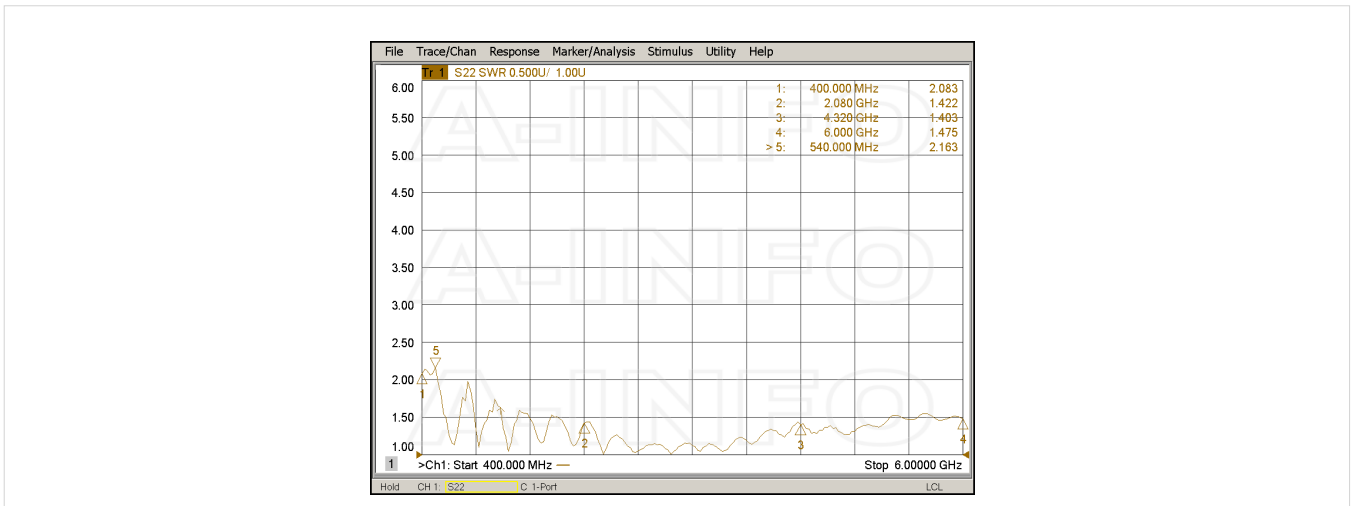

Pattern

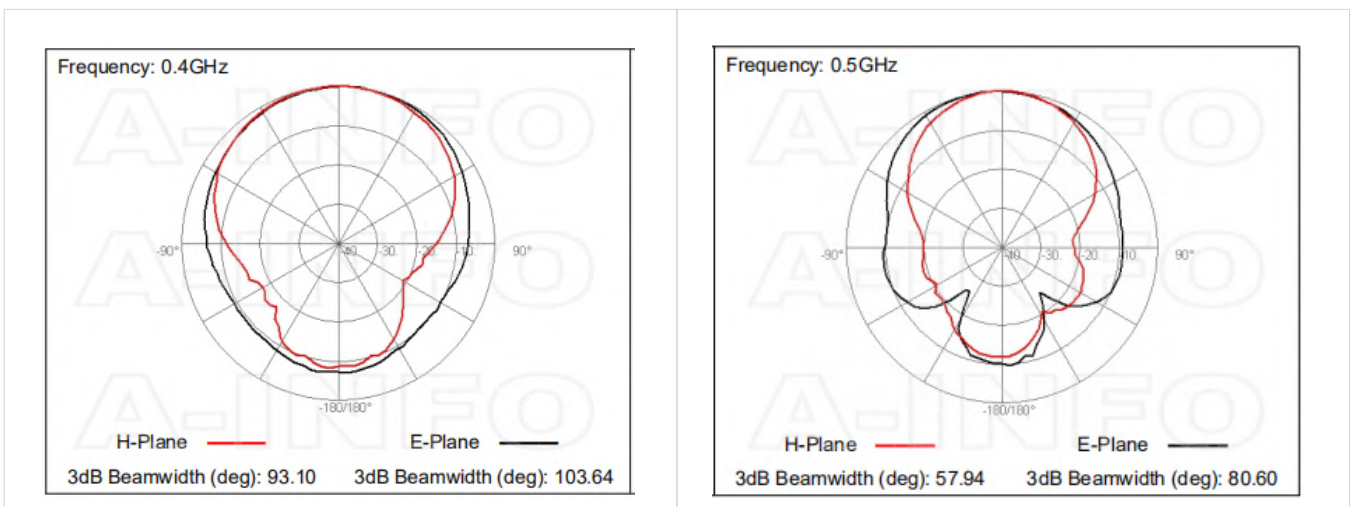

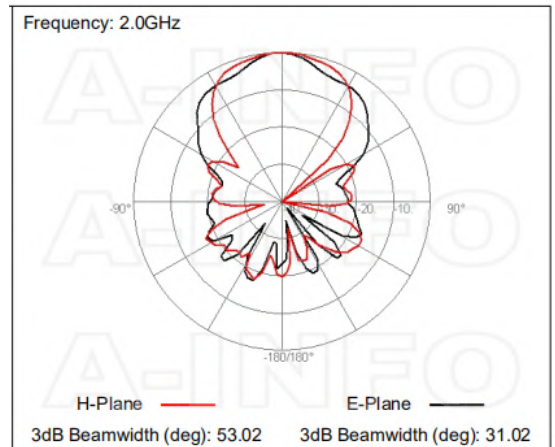
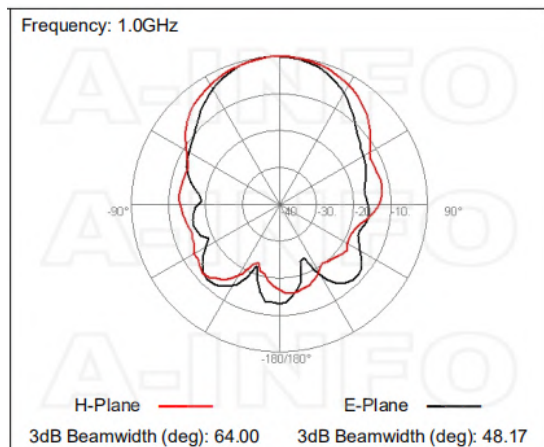
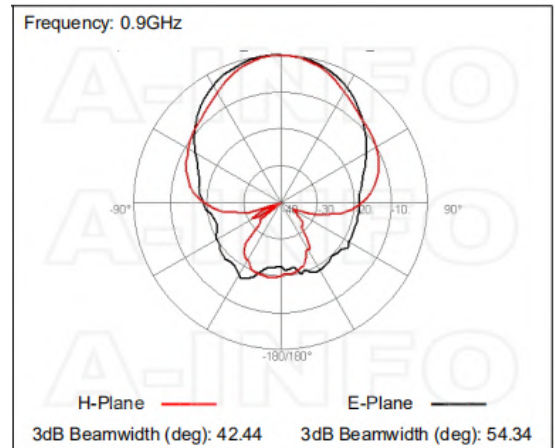
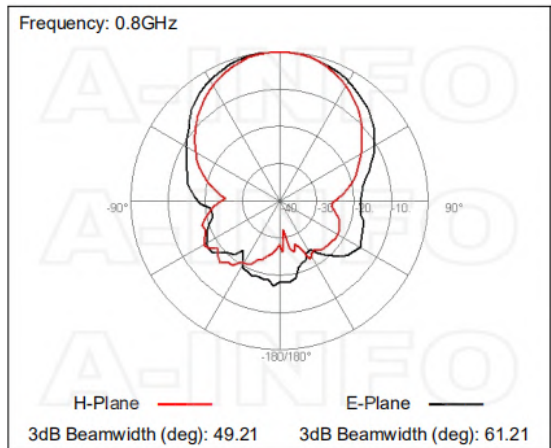
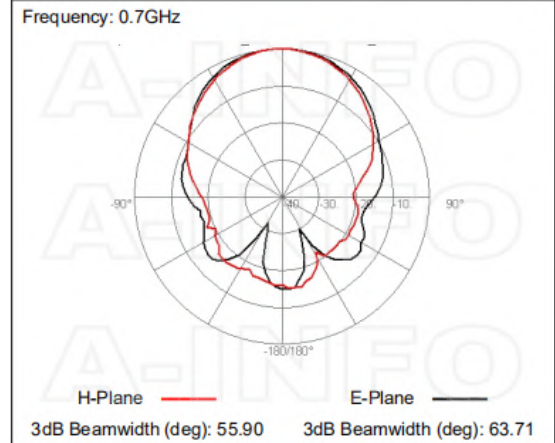
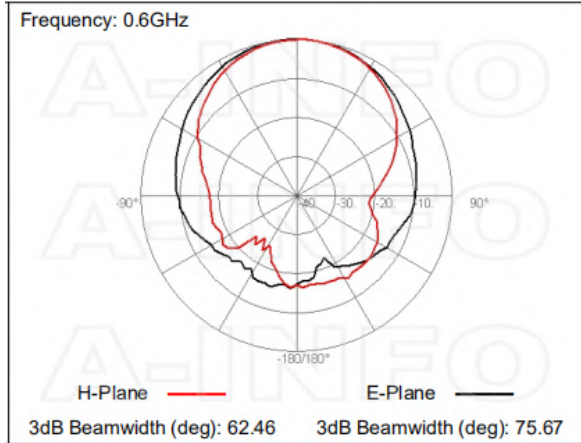

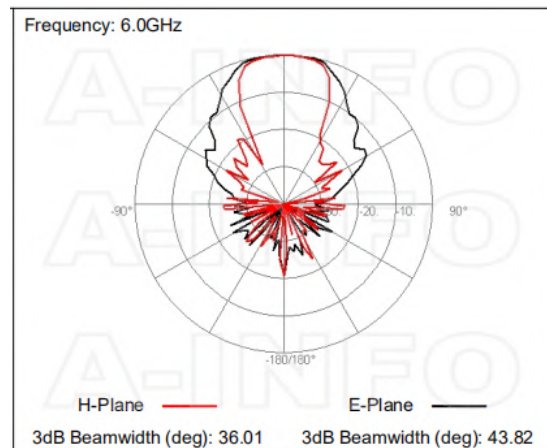
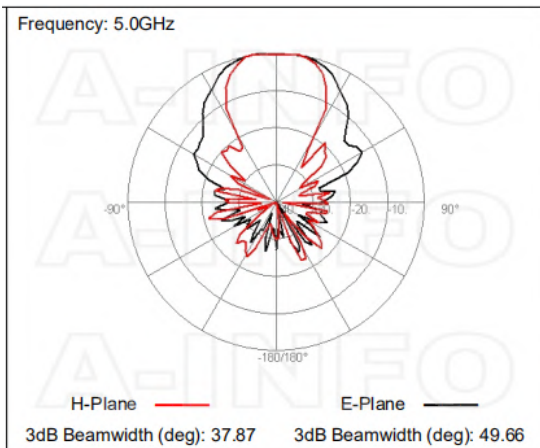
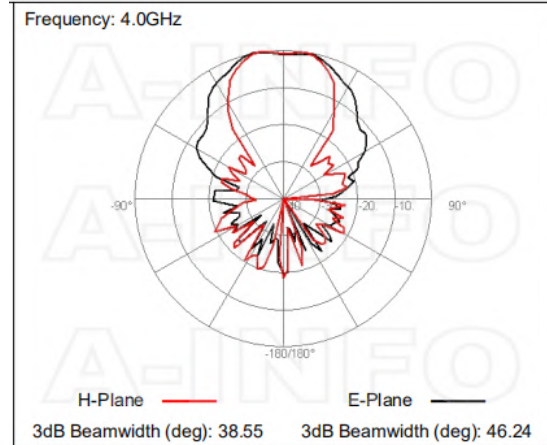
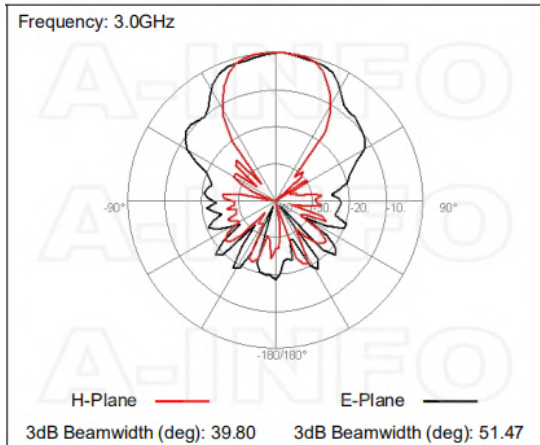

Related Products



LB-460-L L type mounting bracket



Tripod_50Kg Al Alloy Tripod



Carrying Case_LB-460 Al Alloy Carrying Case



NM-NM-A050-1000 Flexible Cable Assembly 1000mm DC-18GHz N Male to N Male



NM-NM-A050-1500 Flexible Cable Assembly 1500mm DC-18GHz N Male to N Male



NM-NM-A050-2000 Flexible Cable Assembly 2000mm DC-18GHz N Male to N Male



NM-NM-A050-3000 Flexible Cable Assembly 3000mm DC-18GHz N Male to N Male



NM-NM-A050-5000 Flexible Cable Assembly 5000mm DC-18GHz N Male to N Male



NM-NM-A050-10000 Flexible Cable Assembly 10000mm DC-18GHz N Male to N Male



NM-NM-A050-20000 Flexible Cable Assembly 20000mm DC-18GHz N Male to N Male



NM-NM-A100-500 Flexible Cable Assembly 500mm DC-18GHz N Male to N Male



NM-NM-A100-1000 Flexible Cable Assembly 1000mm DC-18GHz N Male to N Male



NM-NM-A100-1500 Flexible Cable Assembly 1500mm DC-18GHz N Male to N Male



NM-NM-A100-2000 Flexible Cable Assembly 2000mm DC-18GHz N Male to N Male



NM-NM-A100-3000 Flexible Cable Assembly 3000mm DC-18GHz N Male to N Male



NM-NM-A100-5000 Flexible Cable Assembly 5000mm DC-18GHz N Male to N Male



NM-NM-A100-10000 Flexible Cable Assembly 10000mm DC-18GHz N Male to N Male



NM-NM-A100-20000 Flexible Cable Assembly 20000mm DC-18GHz N Male to N Male

Similar Products



LB-225-NF Broadband Horn
Antenna 0.2-2.5GHz 12dB Gain N
Type Female



LB-225-7/16F Broadband Horn
Antenna 0.2-2.5GHz 12dB Gain
7/16 DIN Female



LB-460-NFSP0 Broadband Horn
Antenna 0.4-6GHz 10dB Gain N
Type Female



LB-560-NF Broadband Horn
Antenna 0.5-6.0 GHz 11dB Gain N
Type Female



LB-560-NFSP0 Broadband Horn
Antenna 0.5-6GHz 11dB Gain N
Type Female



LB-660-NF Broadband Horn
Antenna 0.6-6.0 GHz 11dB Gain N
Type Female



LB-660-NFSP0 Broadband Horn
Antenna 0.6-6GHz 11dB Gain N
Type Female



LB-OSJ-0460-NF Open Boundary
Quad-Ridged Dual Polarization
Horn Antenna 0.4-6GHz 12dB
Gain N Type Female



LB-OSJ-0460-SF Open Boundary
Quad-Ridged Dual Polarization
Horn Antenna 0.4-6GHz 12dB
Gain SMA Female



LB-OSJ-0760-NF Open Boundary
Quad-Ridged Dual Polarization
Horn Antenna 0.7-6GHz 11dB
Gain N Type Female



LB-OSJ-0760-SF Open Boundary
Quad-Ridged Dual Polarization
Horn Antenna 0.7-6GHz 11dB
Gain SMA Female

About this Datasheet

- Product Information

Product Link:
<https://www.ainfoinc.com/lb-460-nf-broadband-horn-antenna-0-4-6-0-ghz-10db-gain-n-type-female>
Data subject to change without notice.
© A-INFO INC. 2024. All Rights Reserved

- Contact Us

Address:
60 Tesla, Irvine, CA 92618,
USA

Website:
www.ainfoinc.com

Email:
sales@ainfoinc.com

- Phone & Fax

Phone:
+1-949-639-9688
+1-949-639-9608

Fax:
+1-949-639-9670