



LB-5400-2.4F Broadband Horn Antenna 0.5-40GHz 12dB Gain 2.4mm Female

Broadband Horn Antenna Operating From 0.5GHz to 40GHz With a Nominal 12dB Gain With 2.4mm Female Connector

Product Information

SKU	LB-5400-2.4F	Patents	ZL202121732730.2 (China)
-----	--------------	---------	--------------------------

Description

Broadband horn antenna LB-5400-2.4F, operating from 0.5 to 40GHz with a nominal 12dB gain and low VSWR 1.6:1 with 2.4mm Female output connector. The model LB-5400-2.4F has uniform gain through its frequency span, providing efficient performance characteristics and directionality. It can handle 10W continuously and 20W peak power. Constructed of lightweight corrosion-resistant aluminum, the antenna will provide years of trouble-free indoor and outdoor service. This broadband horn antenna is linearly polarized and ideally suited for EMI testing, direction finding, surveillance, antenna gain and pattern measurements and other applications..

Technical Specification

Electrical Specification		Interface	
Frequency, Min (GHz)	0.5	Output Type	Coaxial
Frequency, Max (GHz)	40	Connector	2.4mm
Gain, Typ (dBi)	12	Connector Gender	Female
Polarization	Linear	Mechanical Specification	
3dB Beamwidth, E-Plane, Min (Deg.)	17	Body Material	Al
3dB Beamwidth, E-Plane, Max (Deg.)	111	Finish	Chemical Conversion Coating
3dB Beamwidth, H-Plane, Min (Deg.)	15	Size, W (mm)	368.5
3dB Beamwidth, H-Plane, Max (Deg.)	84	Size, H (mm)	264.6
Cross Pol. Isolation, Typ (dB)	35	Size, L (mm)	328
VSWR, Typ	1.6:1	Weight, (kg)	1.32
Impedance, (Ohm)	50		
Power Handling, CW, (W)	10		
Power Handling, Peak, (W)	20		

Additional Information

Application	General Purpose Indoor & Outdoor, Fixed	Solution for	Gain Reference Antenna Measurement Reflector Feed Far-field Measurement System Intergration
-------------	---	--------------	---

Outline Drawing

2.4mm-Female Output (P/N: LB-5400-2.4F)

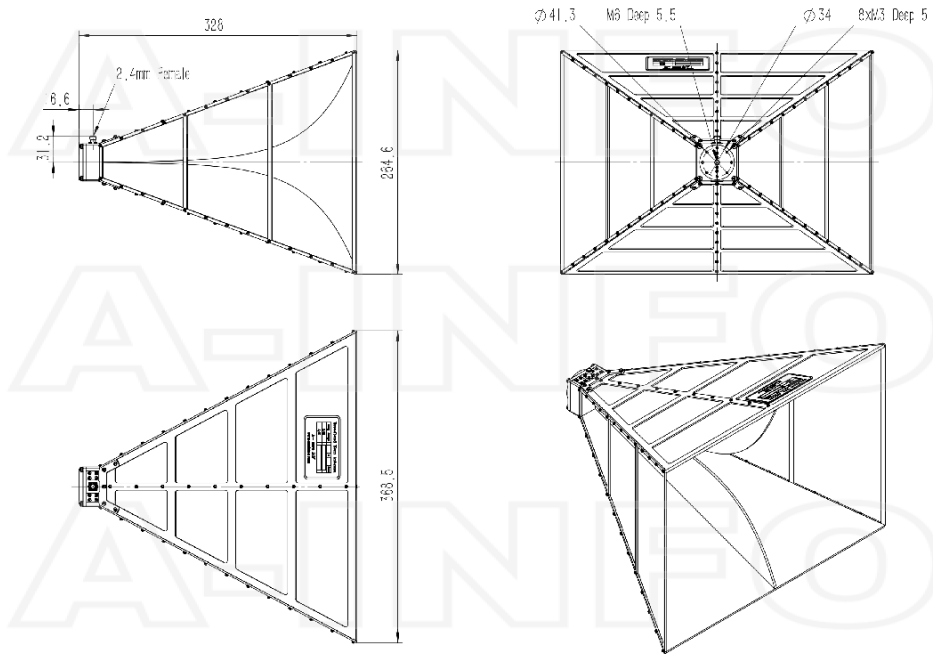

2.4mm-Female Output with L Type Mounting Bracket (Option, P/N: LB-5400-L)

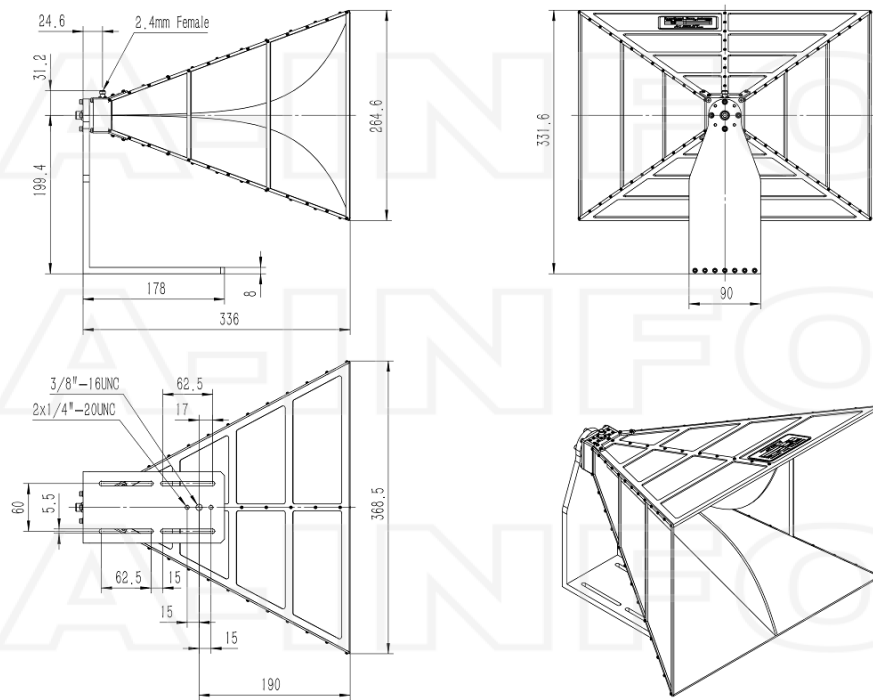

Typical Test Results

Gain

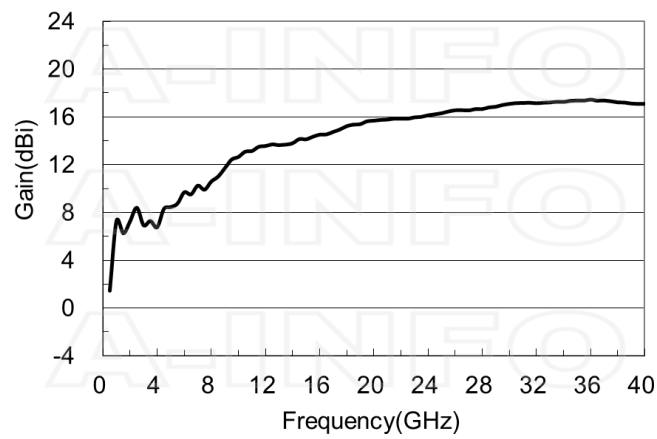

Antenna Factor

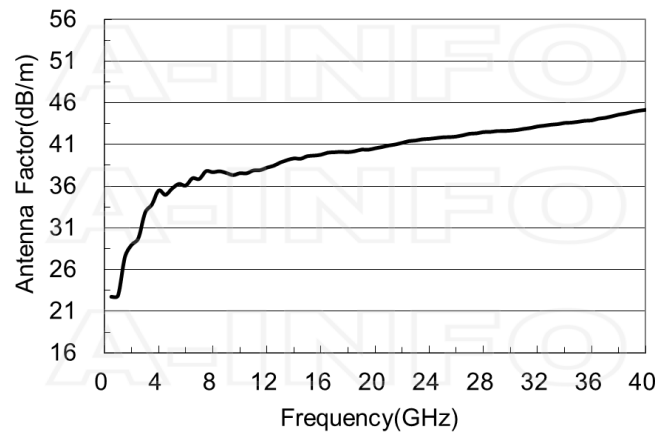

Antenna Factor (Table)

Frequency(GHz)	Gain(dBi)	Antenna Factor(dB/m)
0.5	1.45	22.73
0.6	3.28	22.49
0.7	5.55	21.56
0.8	6.20	22.07
0.9	6.98	22.31
1.0	7.31	22.90
2.0	7.27	28.96
3.0	6.93	32.82
4.0	6.77	35.49
5.0	8.46	35.73
6.0	9.69	36.08
7.0	10.25	36.86
8.0	10.59	37.68
9.0	11.71	37.59
10.0	12.65	37.56
12.0	13.57	38.23
14.0	13.80	39.33
16.0	14.52	39.78
18.0	15.23	40.09
20.0	15.69	40.54
22.0	15.86	41.20
24.0	16.14	41.68
26.0	16.56	41.95
28.0	16.66	42.49
30.0	17.09	42.66
32.0	17.15	43.17
34.0	17.26	43.58
36.0	17.45	43.89
38.0	17.22	44.58
40.0	17.10	45.15

Cross Polarization Isolation

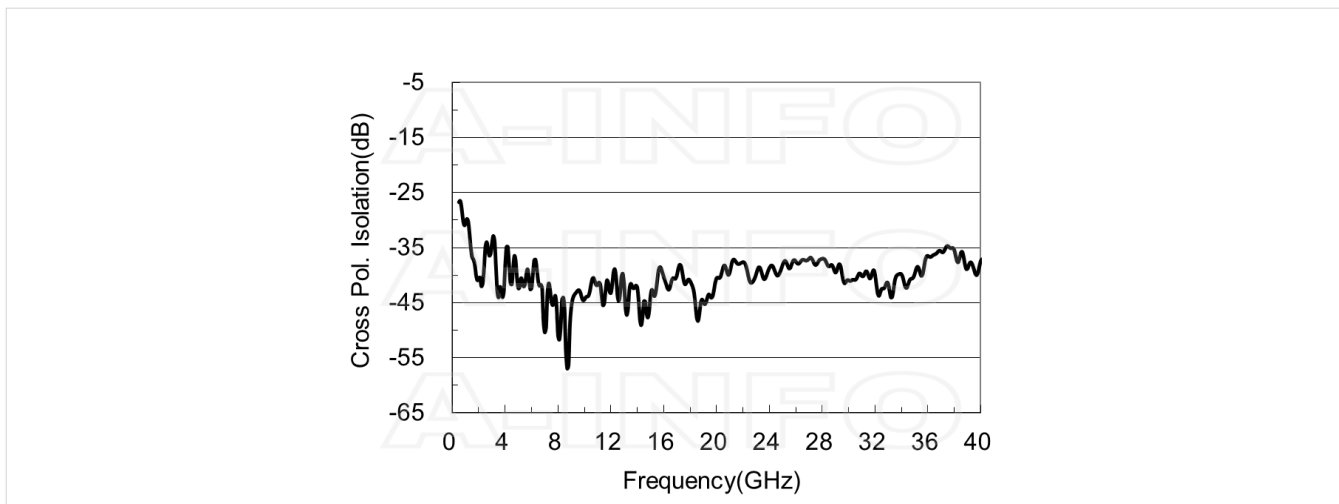

VSWR

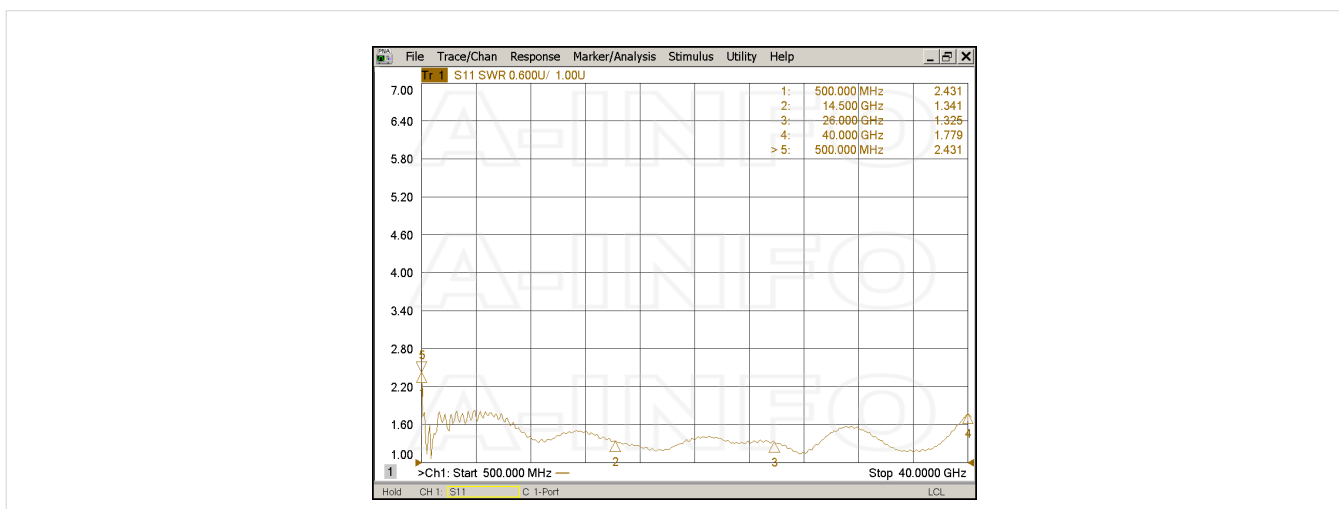

Beamwidth

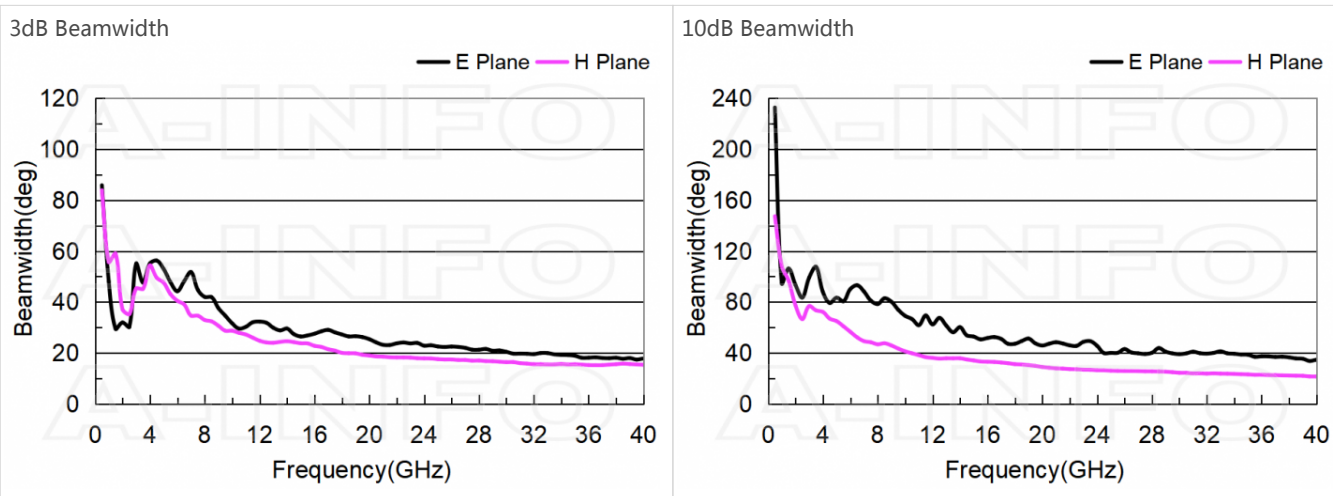

Pattern

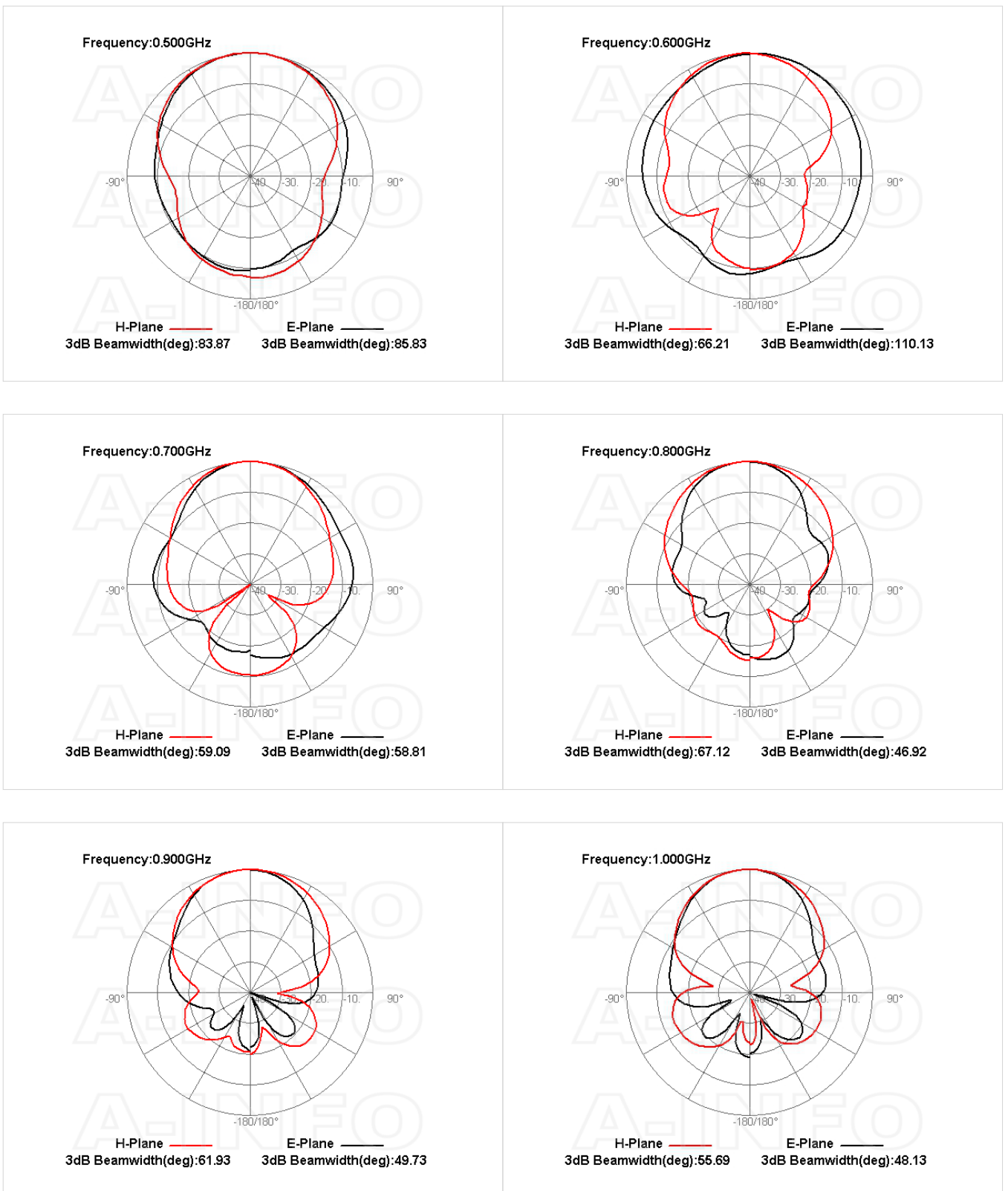

Frequency:2.000GHz

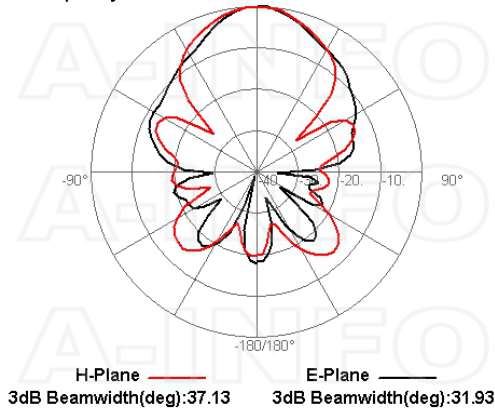

Frequency:3.000GHz

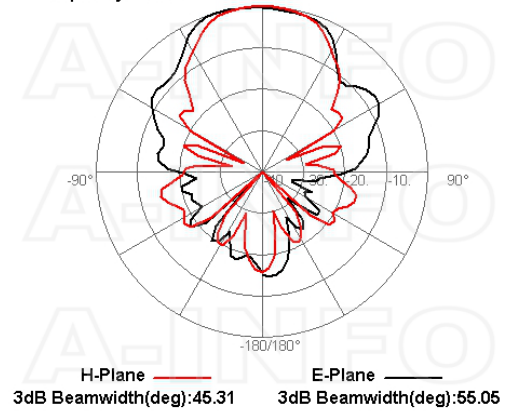

Frequency:4.000GHz

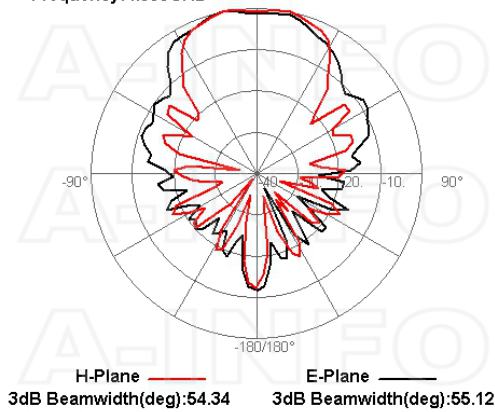

Frequency:5.000GHz

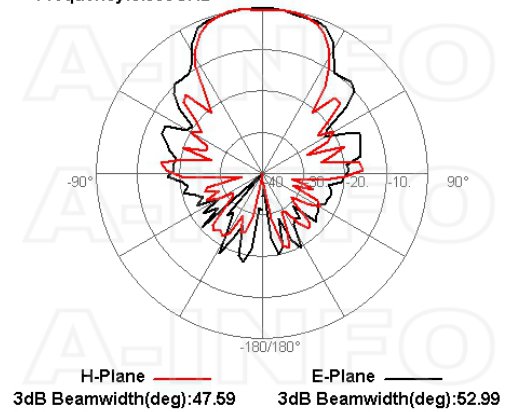

Frequency:6.000GHz

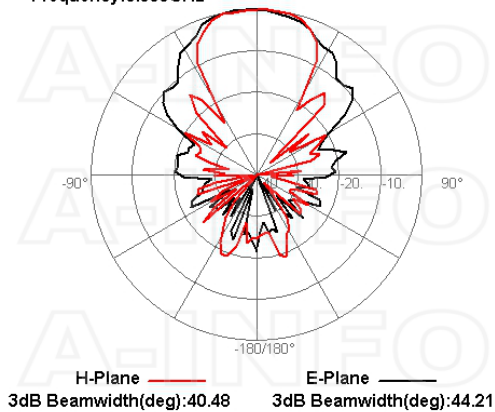

Frequency:7.000GHz

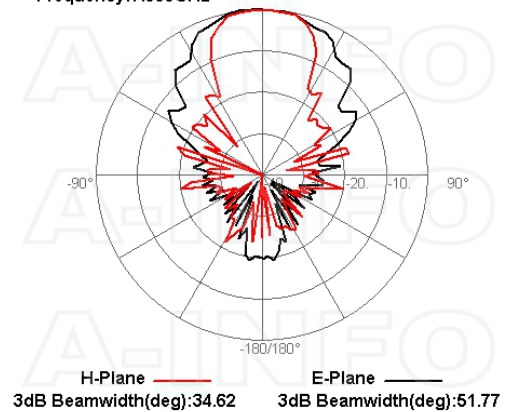

Frequency:8.000GHz

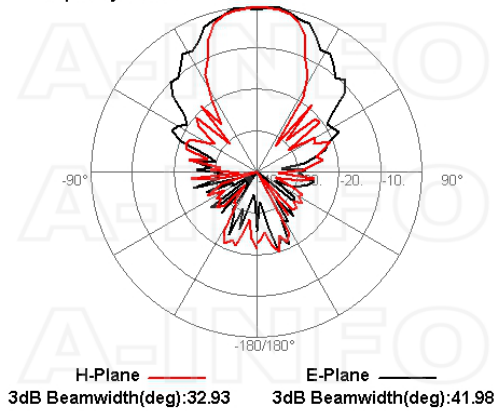

Frequency:9.000GHz

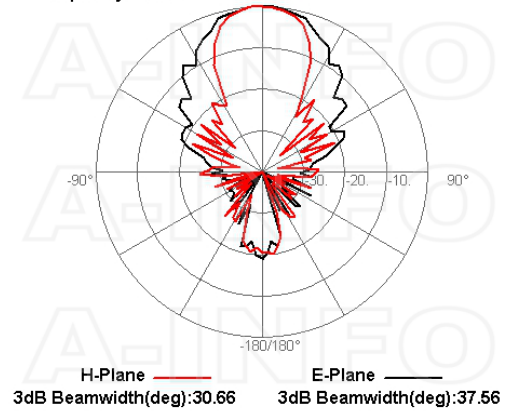

Frequency:10.000GHz

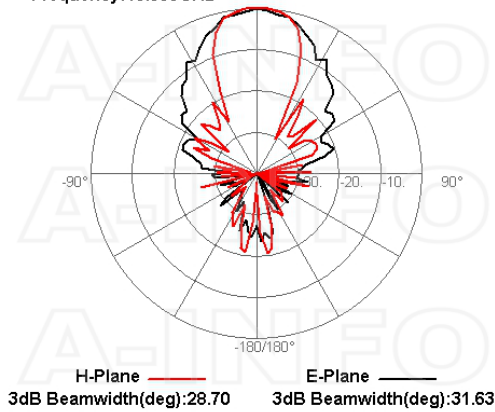

Frequency:12.000GHz

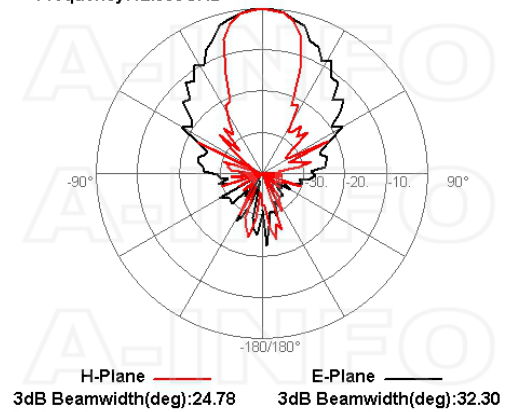

Frequency:14.000GHz

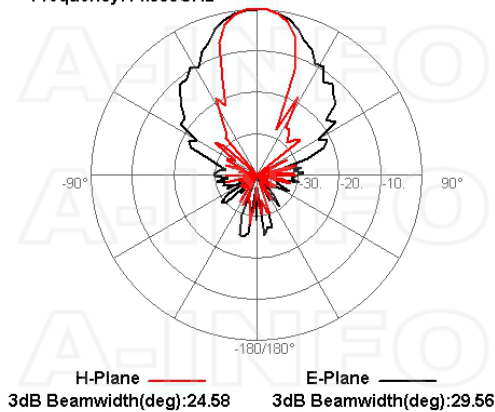

Frequency:16.000GHz

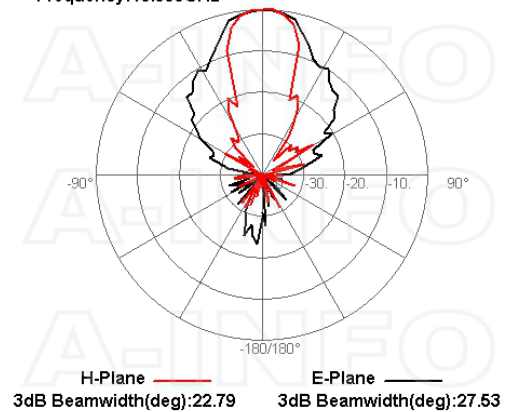

Frequency:18.000GHz

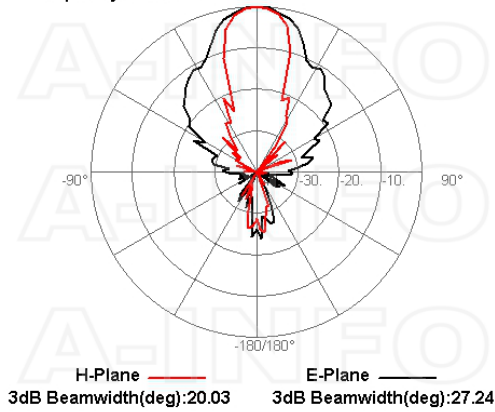

Frequency:20.000GHz

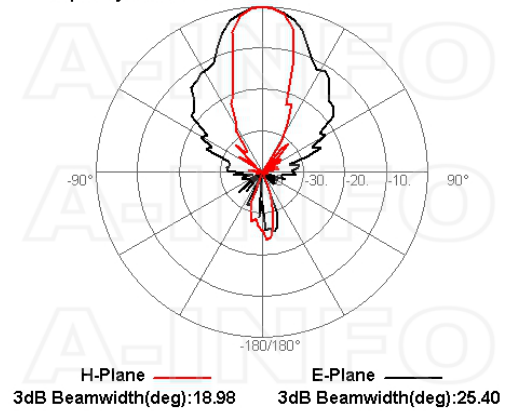

Frequency:22.000GHz

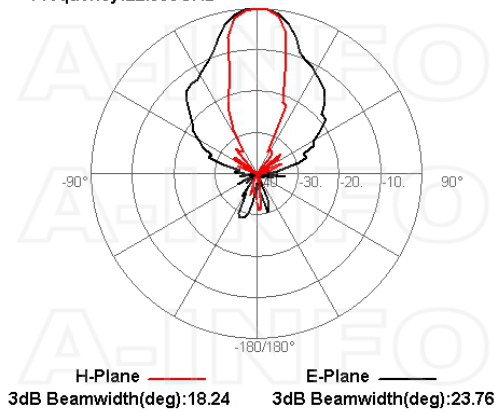

Frequency:24.000GHz

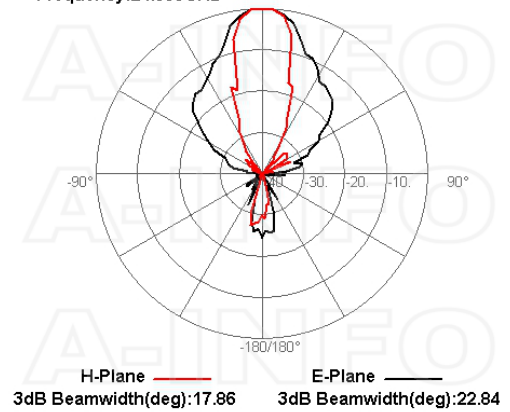

Frequency:26.000GHz

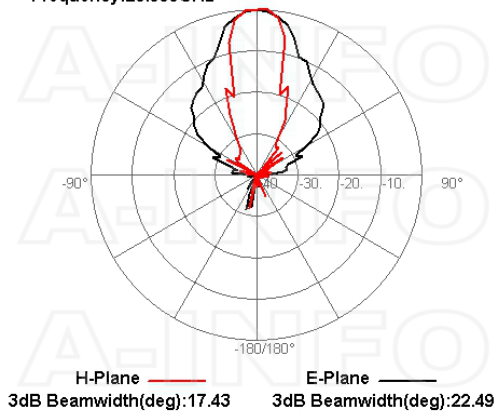

Frequency:28.000GHz

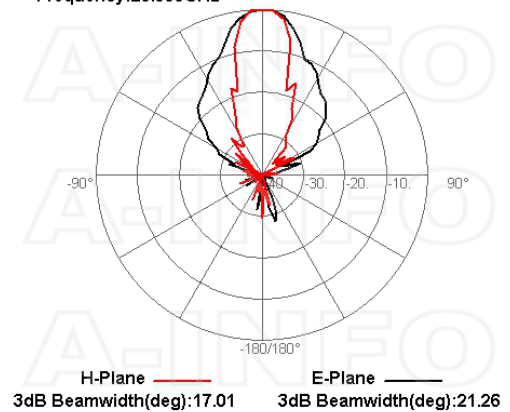

Frequency:30.000GHz

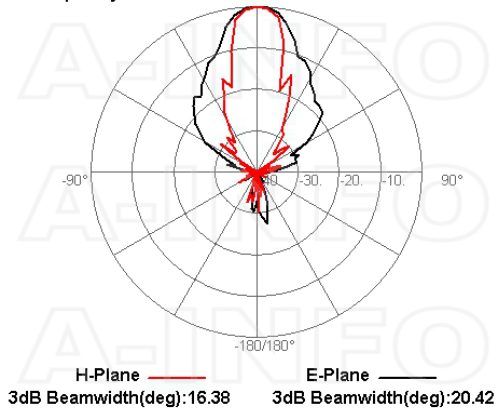

Frequency:32.000GHz

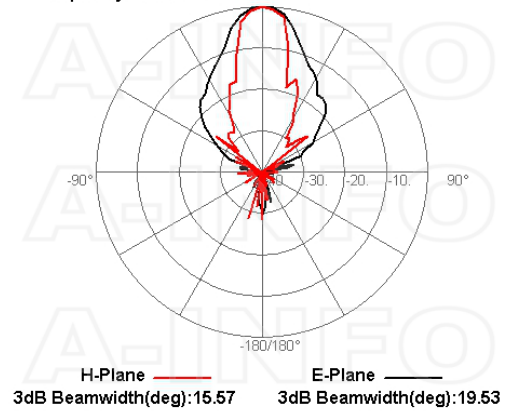

Frequency:34.000GHz

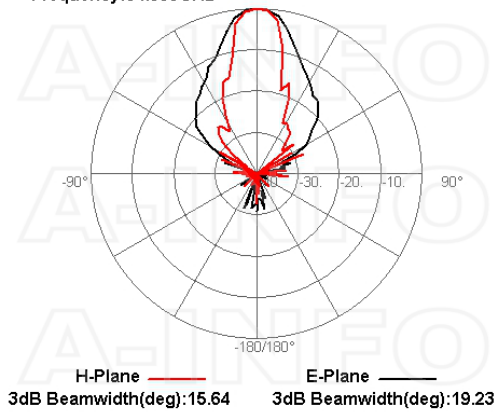

Frequency:36.000GHz

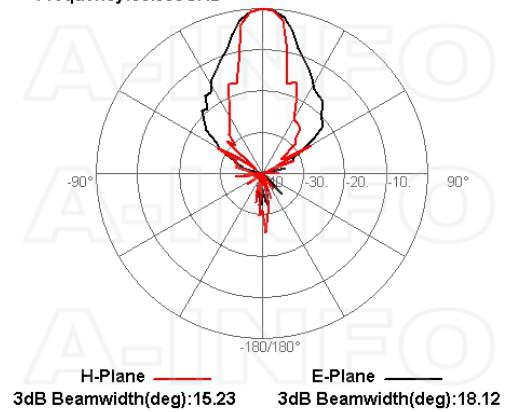

Frequency:38.000GHz

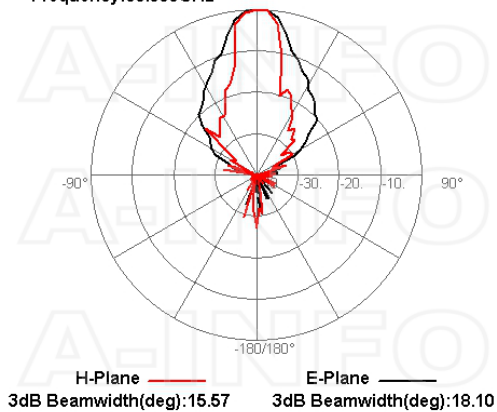

Frequency:40.000GHz

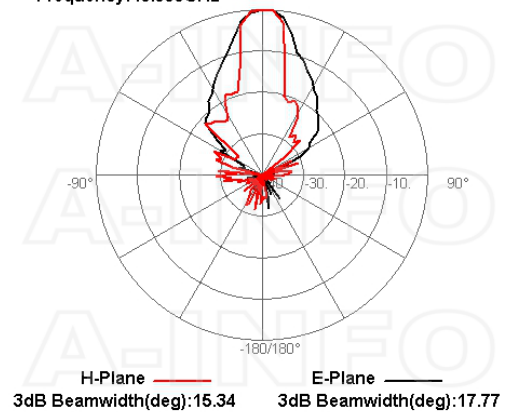

Related Products



LB-5400-L L type mounting bracket



Tripod_15Kg AI Alloy Tripod



3033HL Wooden Tripod



3033QM Wooden Tripod Metalfree



2.4M-2.4M-A050-1000 Flexible Cable Assembly 1000mm DC-40GHz 2.4mm Male to 2.4mm Male



2.4M-2.4M-A050-1500 Flexible Cable Assembly 1500mm DC-40GHz 2.4mm Male to 2.4mm Male



2.4M-2.4M-A050-2000 Flexible Cable Assembly 2000mm DC-40GHz 2.4mm Male to 2.4mm Male



2.4M-2.4M-A050-3000 Flexible Cable Assembly 3000mm DC-40GHz 2.4mm Male to 2.4mm Male



2.4M-2.4M-A050-5000 Flexible Cable Assembly 5000mm DC-40GHz 2.4mm Male to 2.4mm Male



2.4M-2.4M-A050-10000 Flexible Cable Assembly 10000mm DC-40GHz 2.4mm Male to 2.4mm Male



2.4M-2.4M-B020-300 Flexible Cable Assembly 300mm DC-50GHz 2.4mm Male to 2.4mm Male

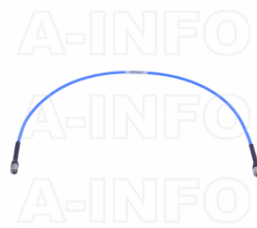

2.4M-2.4M-B020-500 Flexible Cable Assembly 500mm DC-50GHz 2.4mm Male to 2.4mm Male



2.4M-2.4M-B020-1000 Flexible Cable Assembly 1000mm DC-50GHz 2.4mm Male to 2.4mm Male



2.4M-2.4M-B020-2000 Flexible Cable Assembly 2000mm DC-50GHz 2.4mm Male to 2.4mm Male



2.4M-2.4M-B020-3000 Flexible Cable Assembly 3000mm DC-50GHz 2.4mm Male to 2.4mm Male



2.4M-2.4M-B020-5000 Flexible Cable Assembly 5000mm DC-50GHz 2.4mm Male to 2.4mm Male



2.4M-2.4M-B020-10000 Flexible Cable Assembly 10000mm DC-50GHz 2.4mm Male to 2.4mm Male



2.4M-2.4F-B020S-500 Flexible Cable Assembly 500mm DC-50GHz 2.4mm Male to 2.4mm Female



2.4M-2.4F-B020S-1000 Flexible Cable Assembly 1000mm DC-50GHz 2.4mm Male to 2.4mm Female



2.4M-2.4F-B020S-1500 Flexible Cable Assembly 1500mm DC-50GHz 2.4mm Male to 2.4mm Female



2.4M-2.4F-B020S-2000 Flexible Cable Assembly 2000mm DC-50GHz 2.4mm Male to 2.4mm Female



2.4M-2.4F-B020S-3000 Flexible Cable Assembly 3000mm DC-50GHz 2.4mm Male to 2.4mm Female



2.4M-2.4F-B020S-5000 Flexible Cable Assembly 5000mm DC-50GHz 2.4mm Male to 2.4mm Female



2.4M-2.4M-B020-1500 Flexible Cable Assembly 1500mm DC-50GHz 2.4mm Male to 2.4mm Male

Similar Products



LB-5300-KF Broadband Horn Antenna 0.5-30GHz 12dB Gain 2.92mm Female



LB-5300-2.4F Broadband Horn Antenna 0.5-30GHz 12dB Gain 2.4mm Female



LB-5400-KF Broadband Horn Antenna 0.5-40GHz 12dB Gain 2.92mm Female



LB-5500-2.4F Broadband Horn Antenna 0.5-50GHz 12dB Gain 2.4mm Female



LB-4040-KF Broadband Horn Antenna 4-40GHz 13dB Gain 2.92mm Female

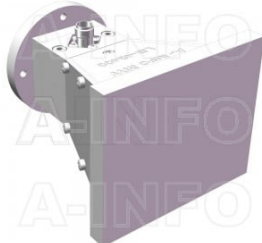

LB-4040-KFSPO Broadband Horn Antenna 4-40GHz 13dB Gain 2.92mm Female



LB-4040-2.4F Broadband Horn Antenna 4-40GHz 13dB Gain 2.4mm Female



LB-4040-2.4FSPO Broadband Horn Antenna 4-40GHz 13dB Gain 2.4mm Female



LB-45500-2.4F Broadband Horn Antenna 4.5-50GHz 13dB Gain 2.4mm Female

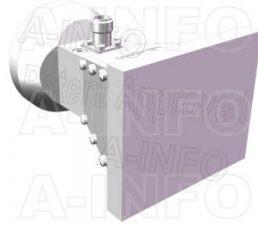

LB-45500-2.4FSPO Broadband Horn Antenna 4.5-50GHz 13dB Gain 2.4mm Female



LB-SJ-40400-KF Broadband Dual Polarization Horn Antenna 4-40GHz 12dB Gain 2.92mm Female



LB-SJ-40400-KFSPO Broadband Dual Polarization Horn Antenna 4-40GHz 12dB Gain 2.92mm Female



LB-SJ-40400-2.4F Broadband Dual Polarization Horn Antenna 4-40GHz 12dB Gain 2.4mm Female



LB-SJ-40400-2.4FSPO Broadband Dual Polarization Horn Antenna 4-40GHz 12dB Gain 2.4mm Female



LB-SJ-50500-2.4F Broadband Dual Polarization Horn Antenna 5-50GHz 12dB Gain 2.4mm Female



LB-SJ-50500-1.85F Broadband Dual Polarization Horn Antenna 5-50GHz 12dB Gain 1.85mm Female

About this Datasheet

<ul style="list-style-type: none"> ● Product Information Product Link: https://www.ainfoinc.com/lb-5400-kf-broadband-horn-antenna-0-5-40-ghz-12db-gain-2-4mm-female Data subject to change without notice. © A-INFO INC. 2024. All Rights Reserved 	<ul style="list-style-type: none"> ● Contact Us Address: 60 Tesla, Irvine, CA 92618, USA Website: www.ainfoinc.com Email: sales@ainfoinc.com 	<ul style="list-style-type: none"> ● Phone & Fax Phone: +1-949-639-9688 +1-949-639-9608 Fax: +1-949-639-9670
---	--	---