



LB-880-NF Broadband Horn Antenna 0.8-8.0 GHz 10dB Gain N Type Female

Broadband Horn Antenna Operating From 0.8 GHz to 8.0 GHz With a Nominal 10 dB Gain With N Type Female Connector

Product Information

SKU	LB-880-NF	Patents	ZL201630454657.5 (China)
-----	-----------	---------	--------------------------

Description

Broadband horn antenna LB-880-NF, operating from 0.8 to 8 GHz with a nominal 10dB gain and low VSWR 1.5:1 with N type Female input connector. The model LB-880-NF has uniform gain through its frequency span, providing efficient performance characteristics and directionality. It can handle 300 W continuously and 500 W peak power. Constructed of lightweight corrosion-resistant aluminum, the antenna will provide years of trouble-free indoor and outdoor service. This broadband horn antenna is linearly polarized and ideally suited for EMI testing, direction finding, surveillance, antenna gain and pattern measurements and other applications.

Technical Specification

Electrical Specification		Interface	
Frequency, Min (GHz)	0.8	Output Type	Coaxial
Frequency, Max (GHz)	8	Connector	N Type
Gain, Typ (dBi)	10	Connector Gender	Female
Polarization	Linear	Mechanical Specification	
3dB Beamwidth, E-Plane, Min (Deg.)	26	Body Material	Al
3dB Beamwidth, E-Plane, Max (Deg.)	110	Finish	Chemical Conversion Coating and Sand Blasting
3dB Beamwidth, H-Plane, Min (Deg.)	24	Size, W (mm)	284
3dB Beamwidth, H-Plane, Max (Deg.)	67	Size, H (mm)	183
Cross Pol. Isolation, Typ (dB)	30	Size, L (mm)	252
VSWR, Typ	1.5:1	Weight, (kg)	2.1
Impedance, (Ohm)	50		
Power Handling, CW, (W)	300		
Power Handling, Peak, (W)	500		

Additional Information

Application	General Purpose Indoor & Outdoor, Fixed	Solution for	Gain Reference Antenna Measurement Reflector Feed Far-field Measurement System Intergration
-------------	---	--------------	---

Outline Drawing

N-Female Output (P/N: LB-880-NF)

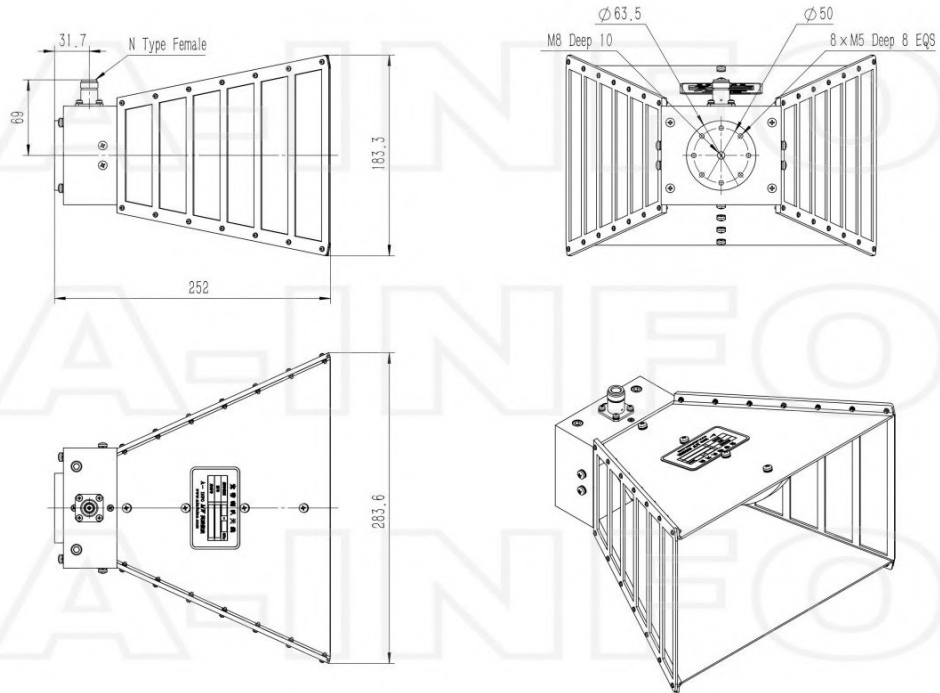

N-Female Output with L Type Mounting Bracket (Option, P/N: LB-10180-L)

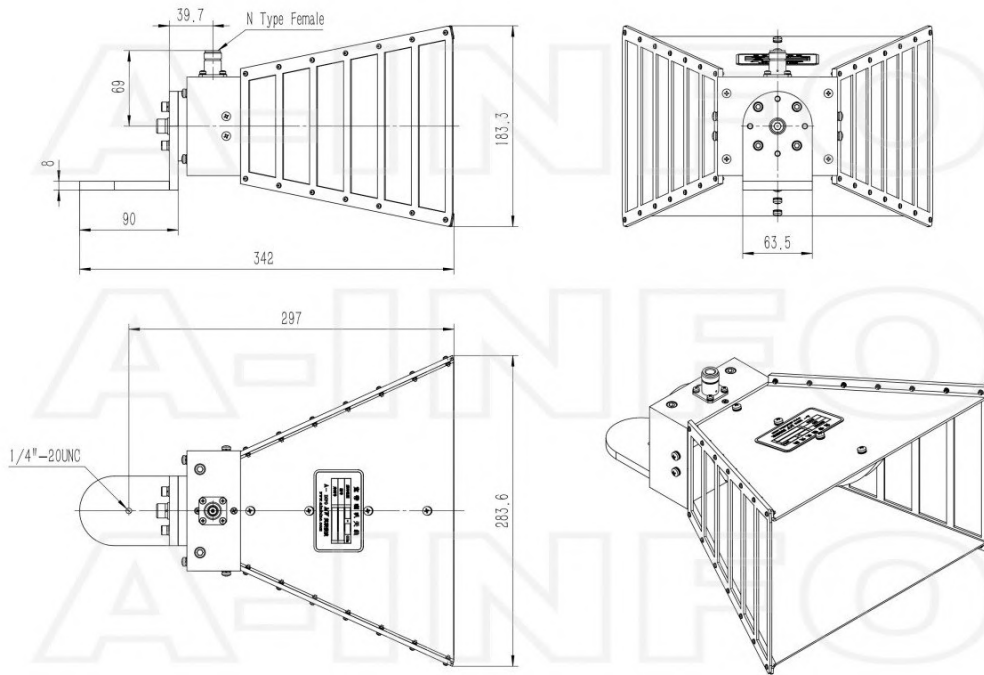

Typical Test Results

Gain

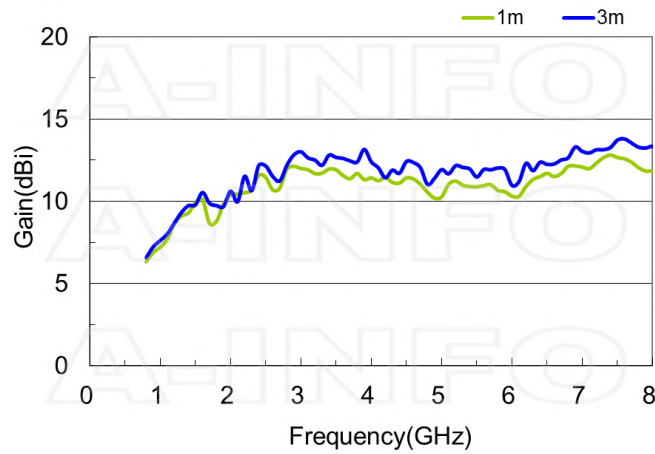

Antenna Factor

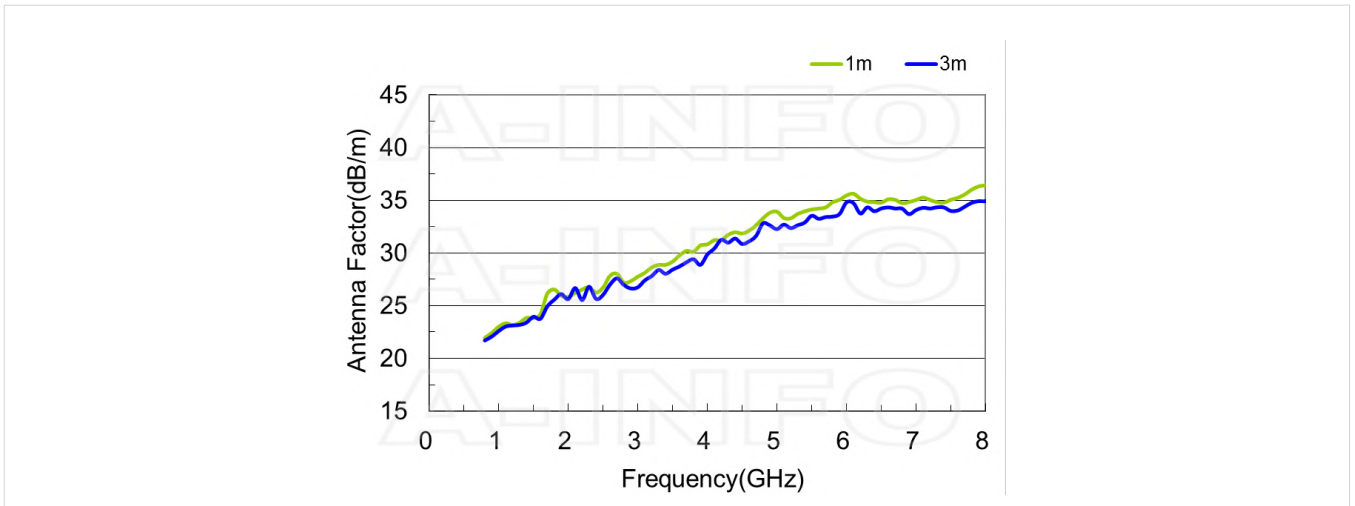

Antenna Factor (Table)

Frequency(GHz)	1m		3m	
	Gain(dBi)	AF(dB/m)	Gain(dBi)	AF(dB/m)
0.8	6.33	21.94	6.58	21.69
0.9	6.88	22.41	7.23	22.06
1.0	7.21	23.00	7.62	22.59
1.5	9.92	23.82	9.78	23.95
2.0	10.40	25.83	10.62	25.62
2.5	11.45	26.72	12.15	26.02
3.0	12.00	27.75	13.01	26.74
3.5	11.91	29.18	12.67	28.42
4.0	11.43	30.82	12.40	29.85
4.5	11.42	31.85	12.42	30.85
5.0	10.27	33.92	11.93	32.26
5.5	10.89	34.13	11.48	33.54
6.0	10.31	35.46	10.97	34.81
6.5	11.70	34.77	12.24	34.22
7.0	12.08	35.03	13.03	34.08
7.5	12.66	35.05	13.72	33.99
8.0	11.83	36.44	13.34	34.93

Field Strength

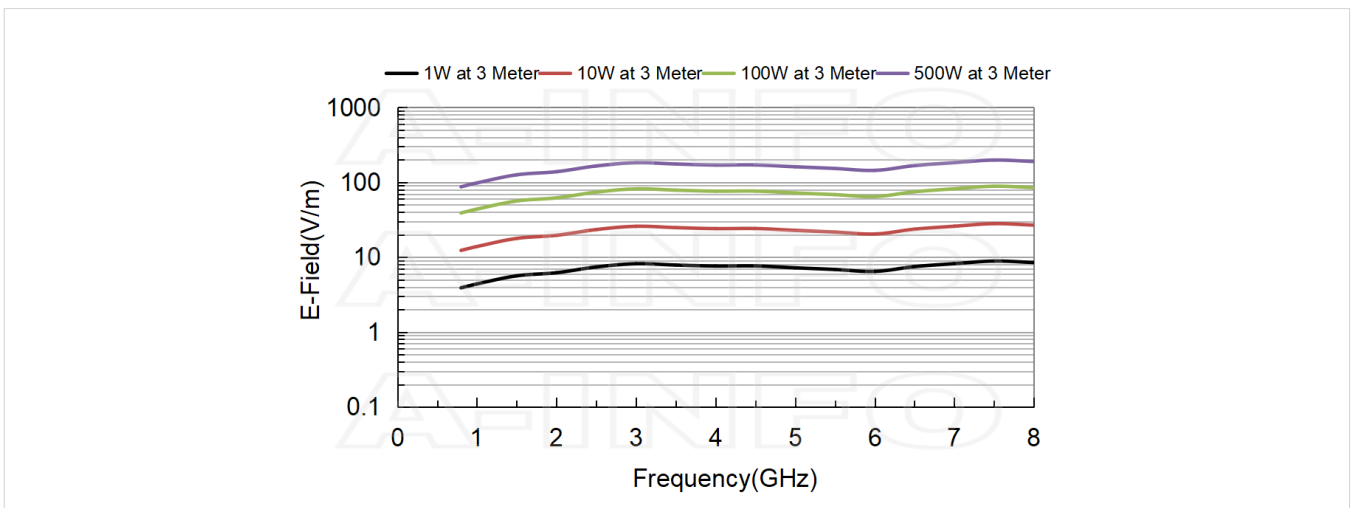
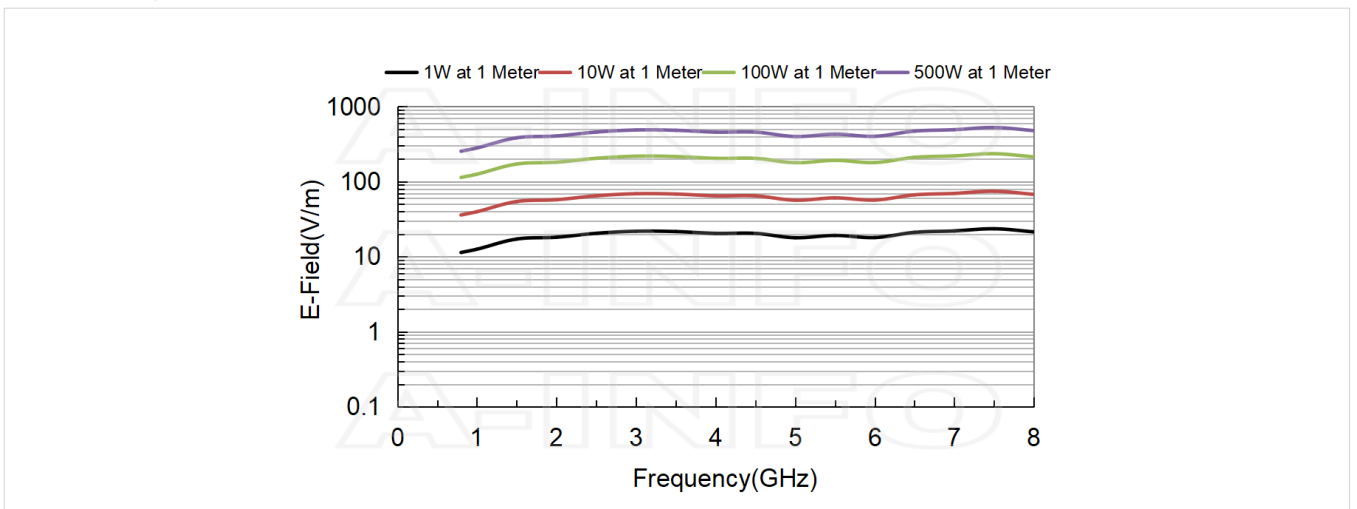

Cross Polarization Isolation

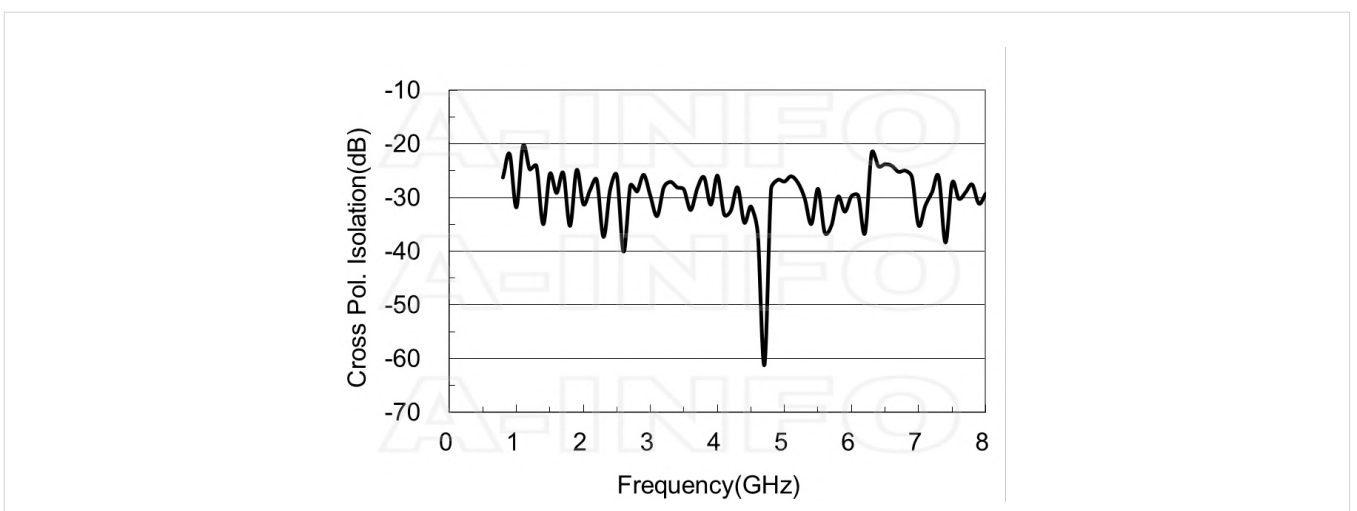

VSWR

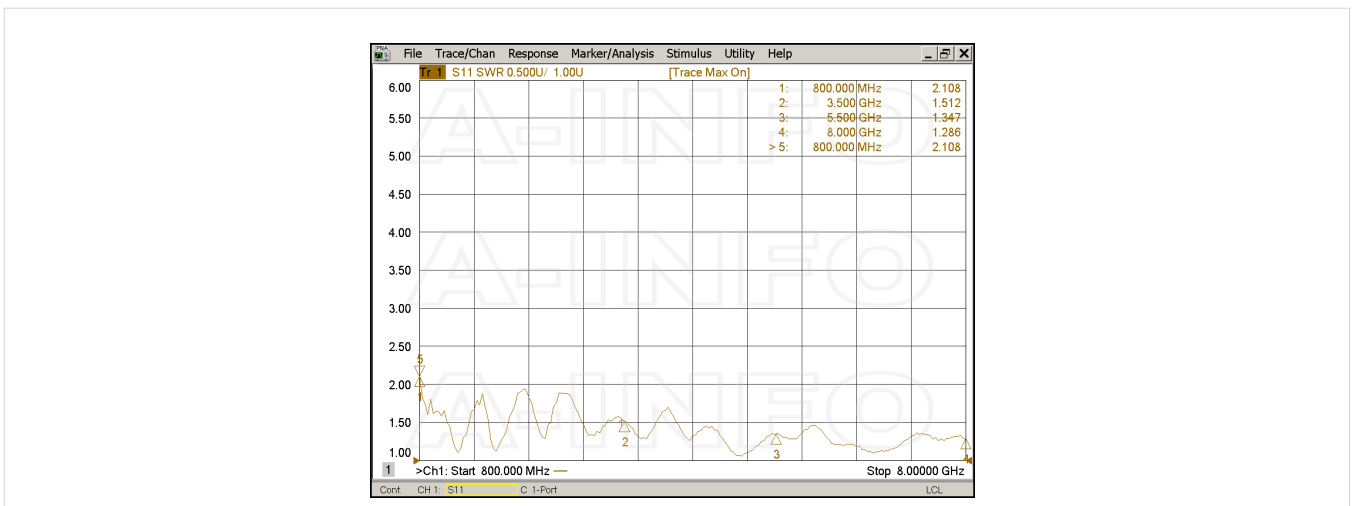

Beamwidth

3dB Beamwidth

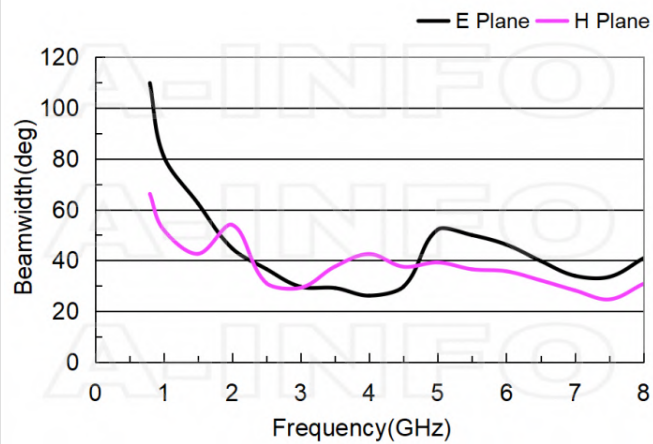

10dB Beamwidth

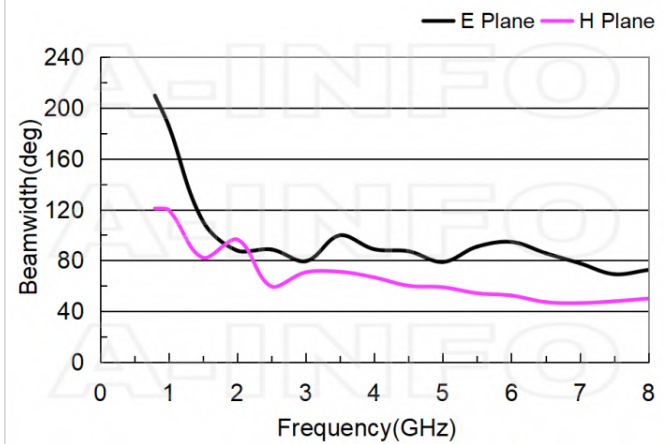

Pattern

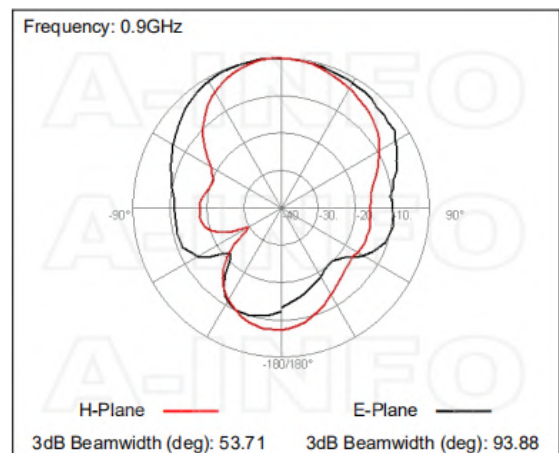
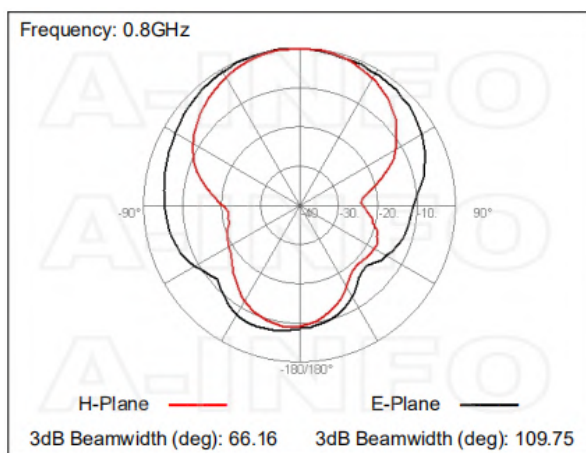

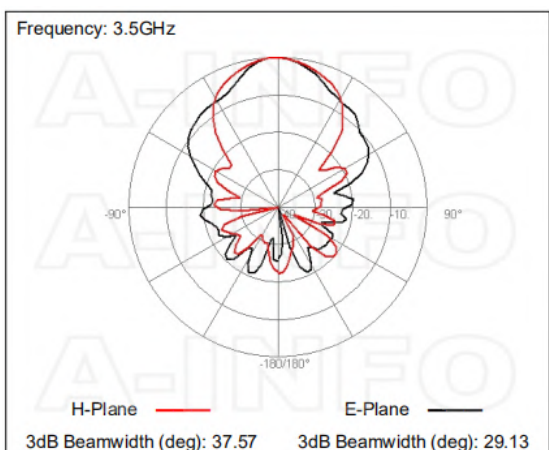
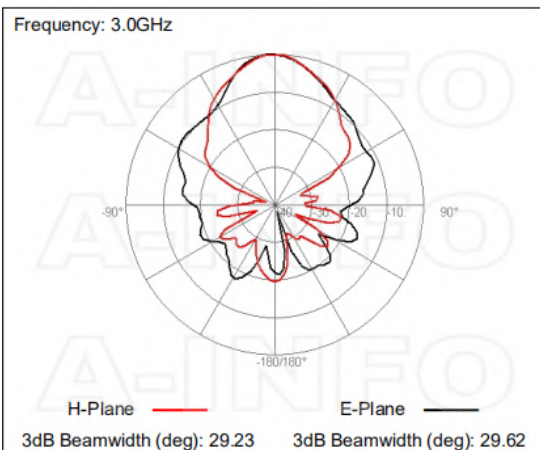
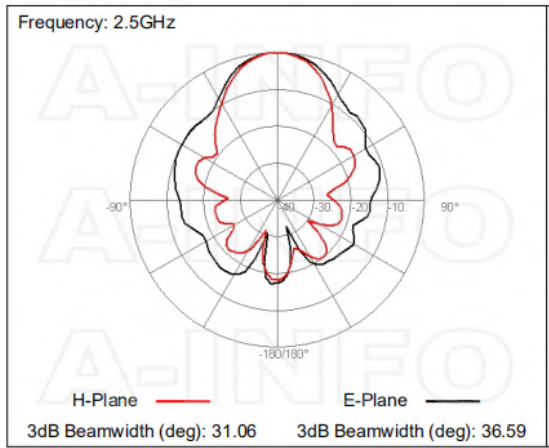
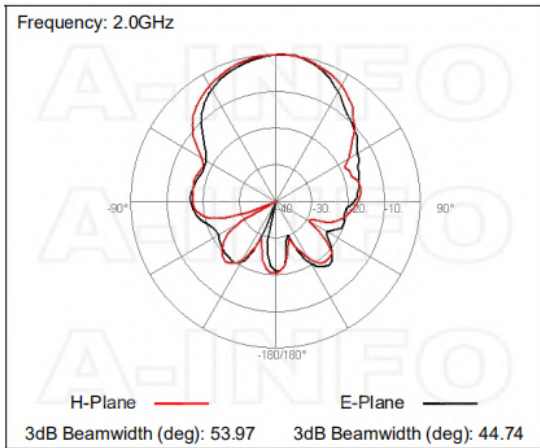
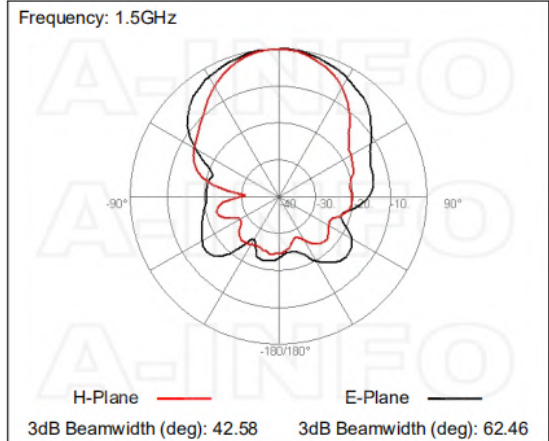
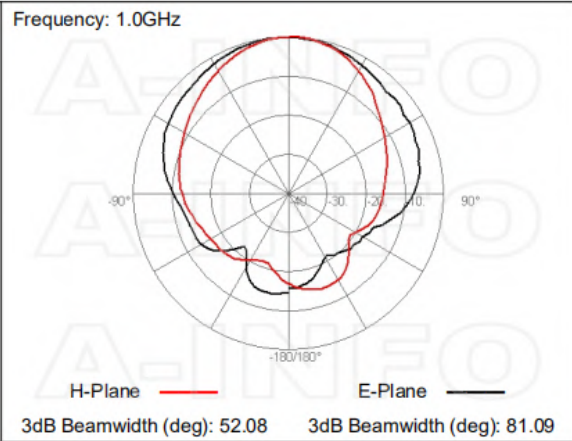

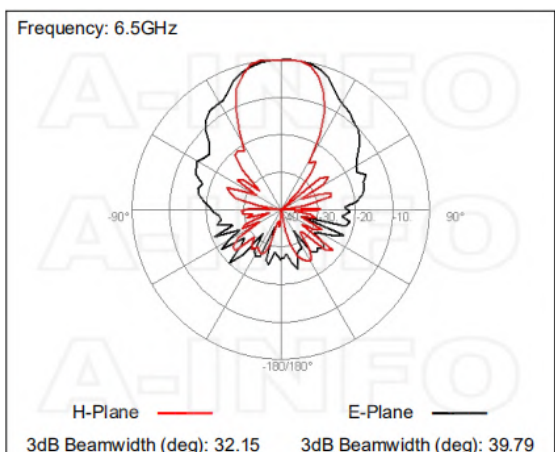
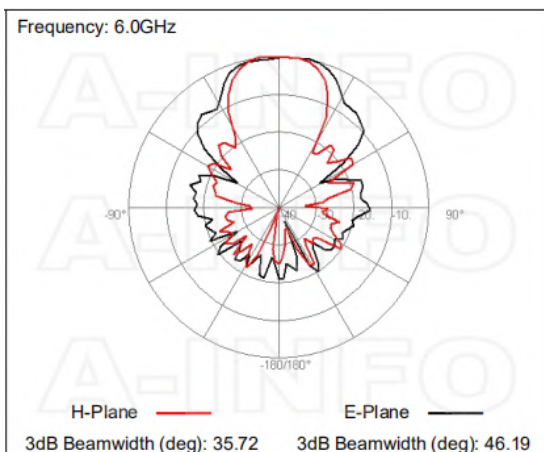
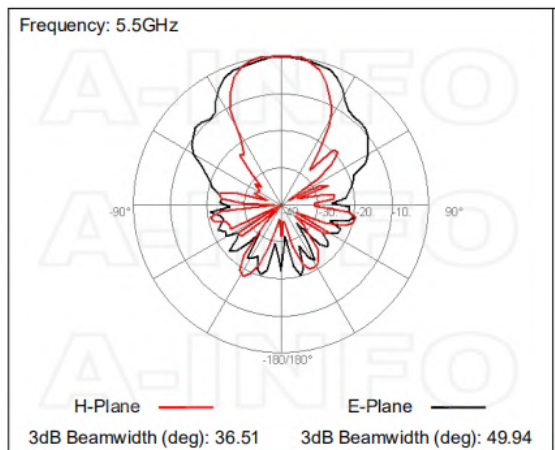
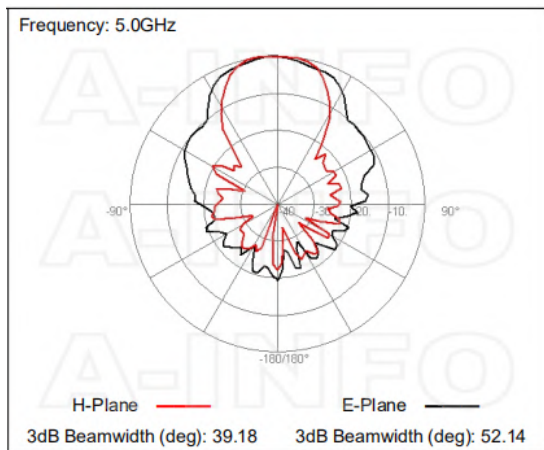
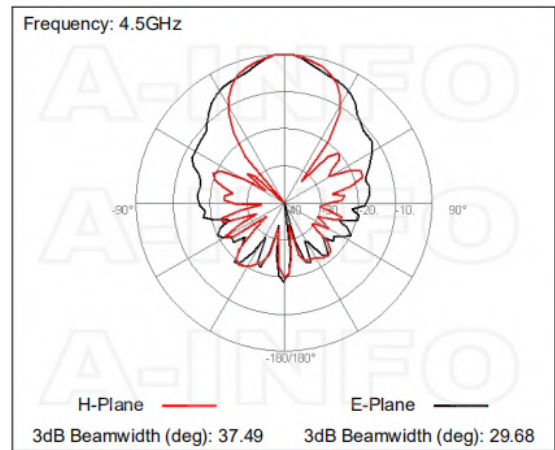
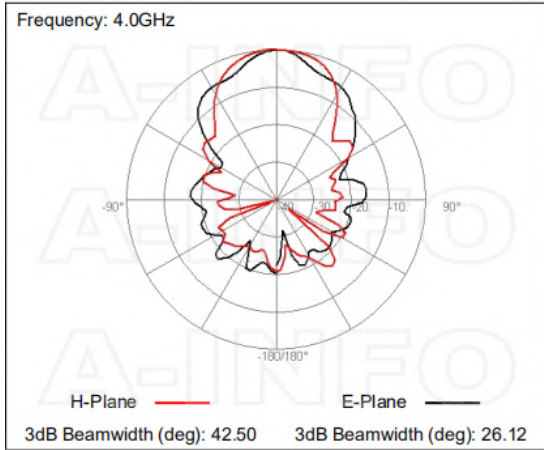

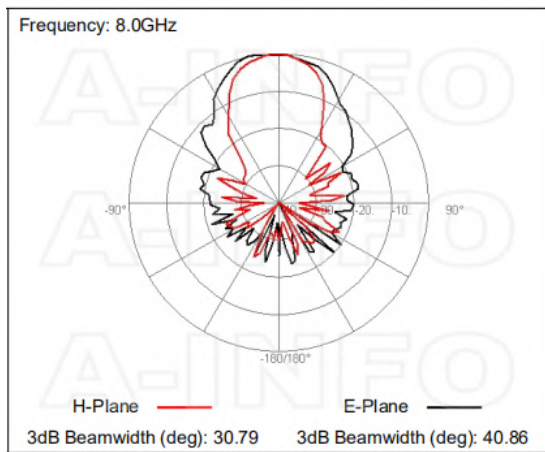
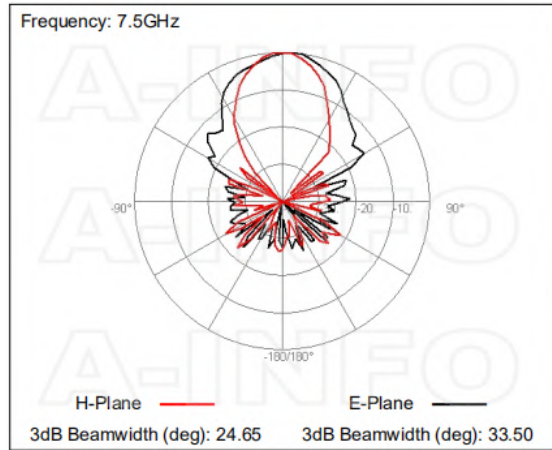
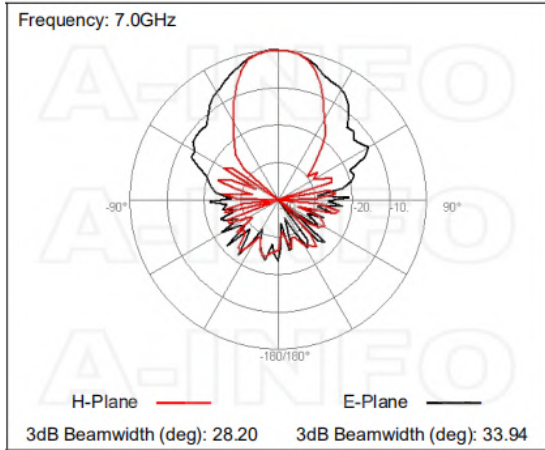

Related Products



LB-10180-L L type mounting bracket



LB-10180-MA Stinger Type Mounting Bracket



Tripod_15Kg Al Alloy Tripod



3033HL Wooden Tripod



3033QM Wooden Tripod
Metalfree



Carrying Case_LB-880 Al Alloy
Carrying Case



NM-NM-A050-1000 Flexible
Cable Assembly 1000mm DC-
18GHz N Male to N Male



NM-NM-A050-1500 Flexible
Cable Assembly 1500mm DC-
18GHz N Male to N Male



NM-NM-A050-2000 Flexible
Cable Assembly 2000mm DC-
18GHz N Male to N Male



NM-NM-A050-3000 Flexible
Cable Assembly 3000mm DC-
18GHz N Male to N Male



NM-NM-A050-5000 Flexible
Cable Assembly 5000mm DC-
18GHz N Male to N Male



NM-NM-A050-10000 Flexible
Cable Assembly 10000mm DC-
18GHz N Male to N Male



NM-NM-A050-20000 Flexible
Cable Assembly 20000mm DC-
18GHz N Male to N Male



NM-NM-A100-500 Flexible Cable
Assembly 500mm DC- 18GHz N
Male to N Male



NM-NM-A100-1000 Flexible
Cable Assembly 1000mm DC-
18GHz N Male to N Male



NM-NM-A100-1500 Flexible
Cable Assembly 1500mm DC-
18GHz N Male to N Male



NM-NM-A100-2000 Flexible
Cable Assembly 2000mm DC-
18GHz N Male to N Male



NM-NM-A100-3000 Flexible
Cable Assembly 3000mm DC-
18GHz N Male to N Male



NM-NM-A100-5000 Flexible
Cable Assembly 5000mm DC-
18GHz N Male to N Male



NM-NM-A100-10000 Flexible
Cable Assembly 10000mm DC-
18GHz N Male to N Male



NM-NM-A100-20000 Flexible Cable Assembly 20000mm DC-18GHz N Male to N Male

Similar Products



LB-780-NF Broadband Horn Antenna 0.7-8GHz 10dB Gain N Type Female



LB-780-NFSPO Broadband Horn Antenna 0.7-8GHz 10dB Gain N Type Female



LB-780-SF Broadband Horn Antenna 0.7-8GHz 10dB Gain SMA Female



LB-780-SFSPO Broadband Horn Antenna 0.7-8GHz 10dB Gain SMA Female



LB-880-NFSPO Broadband Horn Antenna 0.8-8GHz 10dB Gain N Type Female



LB-880-NFSPS Broadband Horn Antenna 0.8-8GHz 10dB Gain N Type Female



LB-880-SF Broadband Horn Antenna 0.8-8.0 GHz 10dB Gain SMA Female



LB-880-SFSPO Broadband Horn Antenna 0.8-8GHz 10dB Gain SMA Female



LB-1080-NF Broadband Horn Antenna 1-8GHz 11dB Gain N Type Female



LB-1080-NFSPO Broadband Horn Antenna 1-8GHz 11dB Gain N Type Female

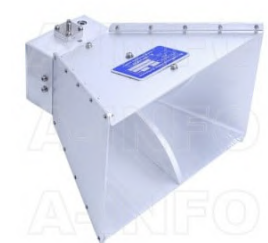

LB-1080-SF Broadband Horn Antenna 1-8GHz 11dB Gain SMA Female



LB-1080-SFSPO Broadband Horn Antenna 1-8GHz 11dB Gain SMA Female



LB-1080-M-NF Broadband Horn
Antenna 1-8GHz 10dB Gain N
Type Female



LB-1080-M-SF Broadband Horn
Antenna 1-8GHz 10dB Gain SMA
Female

About this Datasheet

<ul style="list-style-type: none"> ● Product Information Product Link: https://www.ainfoinc.com/lb-880-nf-broadband-horn-antenna-0-8-8-0-ghz-10db-gain-n-type-female Data subject to change without notice. © A-INFO INC. 2024. All Rights Reserved 	<ul style="list-style-type: none"> ● Contact Us Address: 60 Tesla, Irvine, CA 92618, USA Website: www.ainfoinc.com Email: sales@ainfoinc.com 	<ul style="list-style-type: none"> ● Phone & Fax Phone: +1-949-639-9688 +1-949-639-9608 Fax: +1-949-639-9670
---	--	---